

SERVICE DELIVERY
PRICE QUALITY

POWERRAIL

CREATIVE INNOVATIONS...CONTINUING TRADITION



Locomotive Products

2016 CATALOG

Products and Enhancements

"What Ever It Takes"

POWERRAIL DISTRIBUTION INC.

205 Clark Road, Duryea, PA 18642 USA

Phone: 570.883.7005 • Fax: 570.883.7006

Sales@epowerrail.com • www.ePowerRail.com

TOLL FREE: 1.866.577.6406





POWERRAIL

CREATIVE INNOVATIONS ... CONTINUING TRADITION



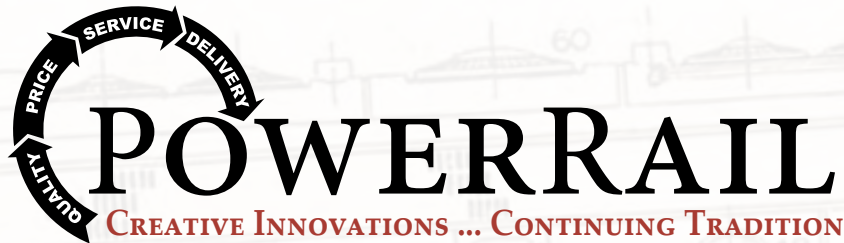

To Our Present and Future Customers:

PowerRail Distribution, Inc. is excited to introduce to you our new and improved 2016 catalog. On behalf of our entire team, I'm sincerely grateful for the ability to produce for our customers another comprehensive catalog featuring PowerRail products, enhancements and capabilities.

We are proud of the growth our family of companies has had since we started this endeavor in 2003. We are continuously expanding PowerRail with new locations every year bringing products and jobs back to the USA. We are always dedicated to achieving our goal of providing the Rail, Power Generation, Transit, and Marine Industry with an alternate source for true AAR M-1003 Quality Parts, Components, and Systems at competitive prices and delivered in a timely manner.

We are pleased to extend our offering of "Enhancement Products" developed with the Solidworks System coupled with our M-1003 Quality System. This symbolizes our attention to customer's needs in providing better solutions to current applications and cost savings, while keeping quality at the forefront.

In addition, we are also proud to expand our innovative "True Blue™" series of re-manufactured parts and components with our "New-UX™" program which gives customers the opportunity to upgrade old cores for new product. Our programs offer true value and quality with unsurpassed flexibility and cost effectiveness.

In an effort to better meet the needs of our customers, we continue to develop our website offering enhanced features and more information about our company, products and the services we offer.

Please feel free to visit the site at WWW.ePowerRail.Com™

Thank you for the opportunity to serve your needs. Should you have any questions regarding our new catalog or our product line, please feel free to call me or any other member of the PowerRail team.

Sincerely,
Paul P. Foster
President & CEO

Dedication at EVERY Turn



CORPORATE



PowerRail Distribution, Inc. was originally formed 2003 in Wilkes-Barre, PA. Today, our Corporate Offices and Main Distribution Center is centered on a 7 Acre + site in Duryea, PA. (a suburb of Scranton) with strategic access to all levels of logistic transportation.



Dedication at EVERY Turn





DISTRIBUTION



Centralized Warehousing



Hand Picked and Double Checked for Accuracy



Bar Coded, Tracking and Packing Slip Issued



Loaded onto Trucks





AVOCA RAIL PRODUCTS



Avoca Rail Products Duryea, Pa. is a precision Production Fabrication Facility utilizing the latest in technology to manufacture Quality Products. The flexibility of running small lots including specialty items to large full production places this facility in a class by itself.

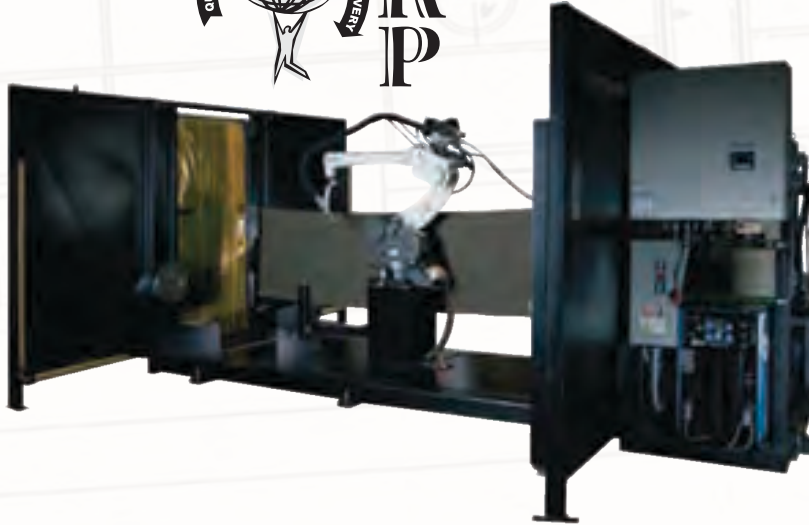

Control Stand Shells

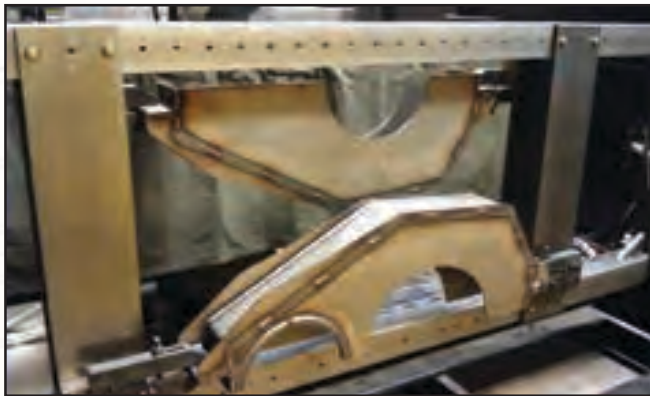

Latest Technology Robotic Fixture - Dual Sides





POWERRAIL INDUSTRIES



PowerRail Industries Duryea, Pa. a former Military and Aviation Machining Facility utilizing the latest in CNC Technology to manufacture Quality Products. The flexibility of running small lots, including specialty items, to large full production places this facility in a class by itself.



CNC Horizontal Dual Pallet Machine



CNC Vertical Milling Centers

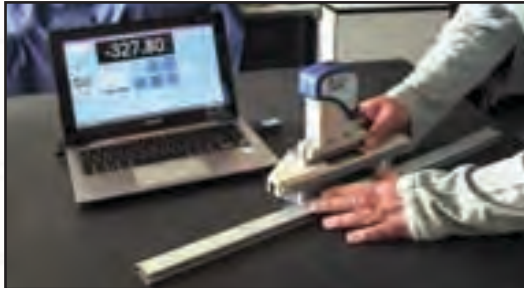

Latest Technology - Measuring Equipment



Latest Technology - Precision Granite Tables



POWERRAIL

CREATIVE INNOVATIONS ... CONTINUING TRADITION



COOPER BEARINGS



Cooper Bearings Inc. Georgetown, Del. has recently moved into their new State-of-the-Art Facility. Cooper Bearings is the leading Expert for Innovation and Quality of Bearings and Journal Boxes used in both Freight and Passenger Transit Locomotives and Cars. In addition we are an M-1003 Certified Company offering New GG Journal Boxes and our **"True Blue Series™"** Unit Exchange Hyatt Journal Boxes. We also offer a complete line of Conversion and Specialty Journal Box and other related Wheel and Axle parts and components.



Precision Technology



Quality Workmanship



Dual Table CNC Milling Center





POWERRAIL ELECTRONICS



PowerRail Electronics Technology, Rincon, Ga. has recently renovated their facility for the third time and built offices to support the Quality, Engineering and Office Team.

PowerRail Electronics offers a full line of New and **"True Blue Series™"** Unit Exchange Contactors, Relays, Control Stands, Cabinets, Engine Protectors and other related parts & components. We pride ourselves in utilizing parts and components that we developed to meet or exceed original OEM specifications. Our standards ensure the end user receives a quality part that will be both reliable and functional.



Control Stand Wired & Tested

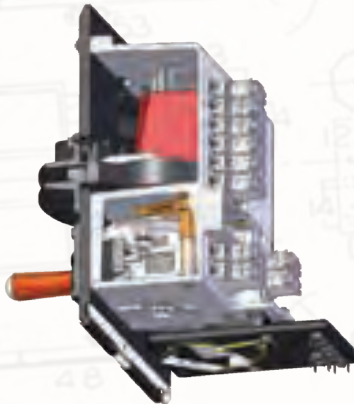

Contactors / Relay Work Station



Latest in Technology Test Equipment



EPD Test Cell





POWERRAIL MANUFACTURING



PowerRail Manufacturing, Connersville, Ind. offers a complete line of **"True Blue Series™"** Unit Exchange Air Compressors, Roots Blowers, Water, Oil & Fuel pumps and other related Engine components. In addition, we have expanded our line to include New Rocker Arms, Valve Bridges, Starters and Pumps utilizing parts and components that we developed to meet or exceed original OEM specifications. This, coupled with our OEM Verification process, will provide our customers with True Reliability in our product.



Roots Blower Scroll Precision Balancing

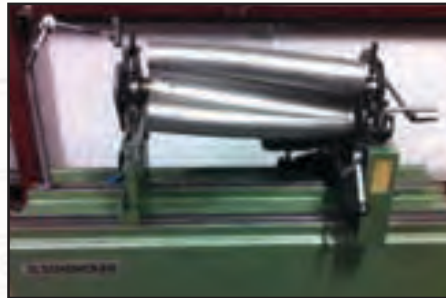

Roots Mercury Type Test Load Cell

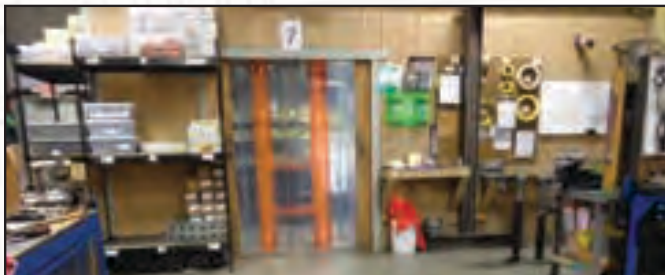

Environmental Clean Room #7 - Starters & Fuel Pump Motor Production



Water & Oil Pump Stations



Air Compressor Test Cell



AESS Starter Test Cell





POWERRAIL LOCOMOTIVE SERVICES



PLS

PowerRail Locomotive Services Monroe Ga. Opened in 2014. This 17+ Acre Locomotive Facility offers both Locomotive and Freight Car service including Light Repair, Running Repair, Re-wires, Traction Motor, Truck Work, Engine and/or Engine Component Change Out. We have also branched out with PowerRail Mobile Services which will provide the End Customer Mobile Services on site.



PowerRail Mobile Maintenance



POWERRAIL

CREATIVE INNOVATIONS ... CONTINUING TRADITION



RAIL & TRACTION



Rail & Traction, ST. Thomas, Ontario, Canada are the leading Expert for Innovation and Quality of Traction Motor and other related Electrical Locomotive Rotating Parts and Components.

Rail & Traction's Quality and Products are well established not only in North America but also Internationally.

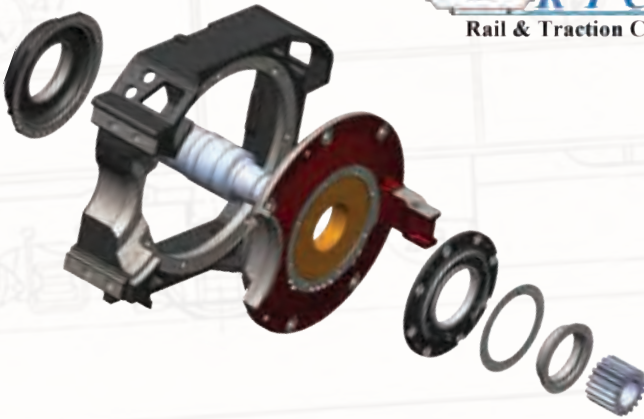



POWERRAIL DISTRIBUTION ENGINEERING



PowerRail Distribution Certified AAR M-1003 Quality



The **AAR M-1003 Certification** is a highly regarded mark of Quality in the Industry. It demonstrates that PowerRail Distribution Inc. and its divisions have implemented strict **Quality Procedures**. These procedures lead to quality parts and components being produced and delivered in a timely manner.

Besides using SolidWorks® software to create TRUE 3-D Solid Models, Drawings and Renderings, we have implemented Ultra-Accurate CMM Inspections in our NEW Clean Room.

By coupling these two technologies together, we are able to assure the end user, a quality part that will be reliable and functional

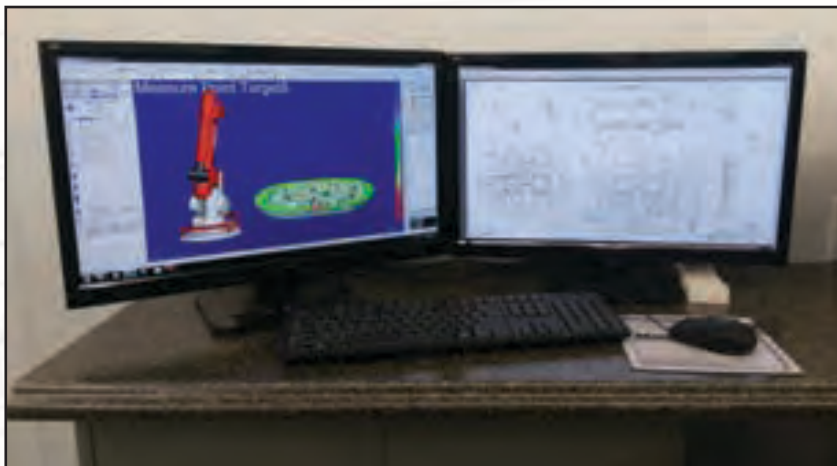

Environmentally Controlled Clean Room



CMM Measuring for Accuracy





POWERRAIL DISTRIBUTION ENGINEERING

"Uniting, Innovation, Engineering, Manufacturing and Distribution"

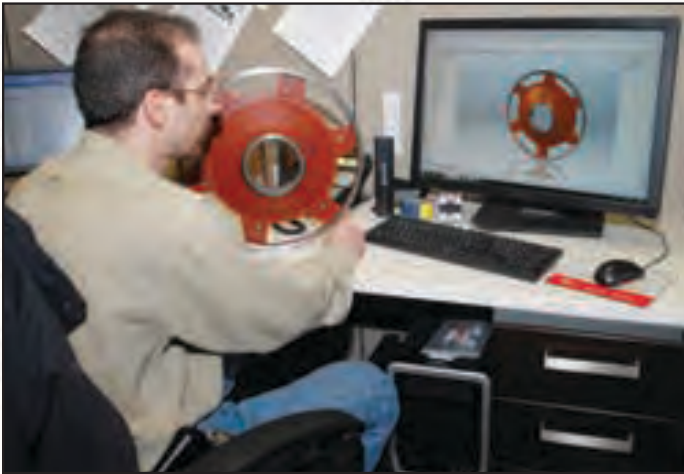

Senior Engineer Creating a Rendering in SolidWorks®

Our Enhanced M-1003 Quality System is coupled to our Advanced Engineering Resources and Support. Which Utilize SolidWorks® CAD Software to Create and Analyze Solid Models, Drawings and TRUE 3-D Renderings.

This CMM MASTER3D Gauge is an Ultra-Accurate 6 axis Arm used for precise, Measuring, Reverse Engineering, Building, and Analysis.

- **Certification: ASME B89.4.22**
- **Probing volumetric accuracy: +/-0.025mm (.00098in)**
- **Probing point repeatability: 0.014mm (.00055in)**

By coupling these two technologies together, we are able to assure the end user, a quality part that will be reliable and functional.

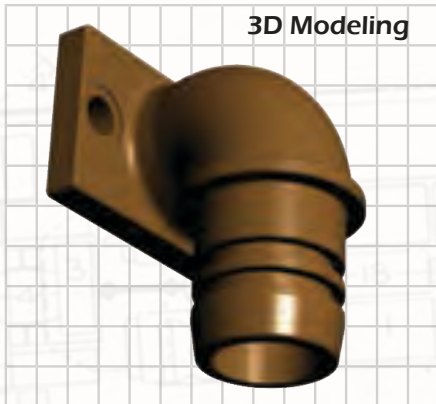

3D Modeling

www.EPowerRail.com
has Actual Working Models

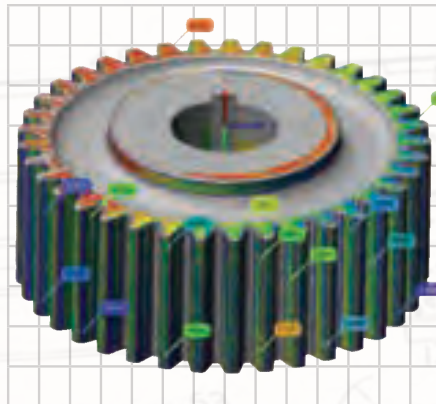

Dimensional Overlay of
OEM vs. PowerRail Gear

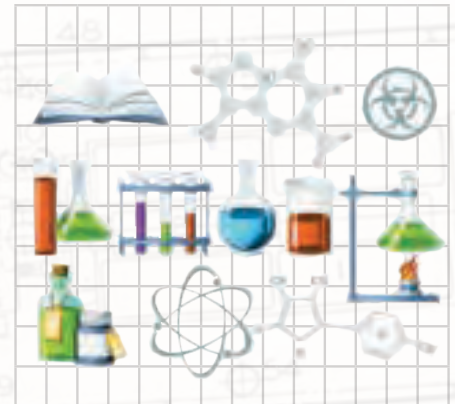

Independent Lab Reports

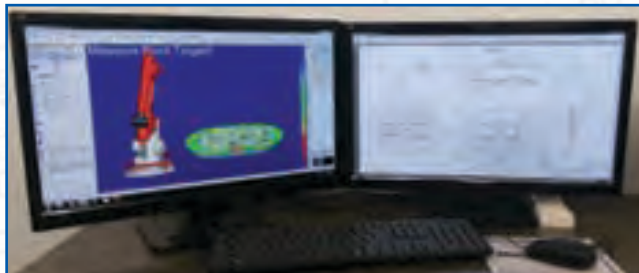
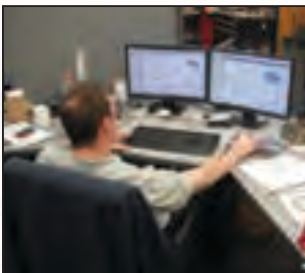

3D Scan and or CMM



Failure Analysis





Alphabetical Index

Description	Page	Description	Page	Description	Page	Description	Page	Description	Page
Air Brake	28	Circuit Breaker	47	Fuel Pump	63	Modesty Locks	53	Spark Arrestor	101
Air Conditioner	29	Compressor Air	49-50	Fuse Holder	73	Modules	52, 89	Springs	100
Air Horns	29	Compressor Water	49-50	Fuses	72	Name Plates	89	Starter Motors	102
Alternator	30	Contactors - Controllers	52	Gages	73	Oil Cap	78	Support Bearings	104
Axle Generator	29	Control Stands	51	Gaskets	65	Oil Pump	62	Supports, Brackets and Handrails	103
Ball Valves	31	Coupler, Yoke & Draft Gears	48	Gearcase	74-77	Pinion Bull Gear	90	Swing Hangers	108
Batteries	31	Diodes	54	Gearcase Seals	78	Pipe Clamp Brackets	91	Switches	105-107
Bearings	32	Door - Battery Grating	53	Generator	79	Power Assy	56-57	Terminal Boards	109
Brake Handles	32	Door - Cab	53	Handrail	80	Refrigerator	93	Terminal Lugs	118
Brake Hand-wheel	34	Door - Carbody	54	Heat Exchanger	92	Relays	52	Terminals	47
Brake Products	32	Door Locomotive Flooring	53	Heat Shield	83	Resistor Grids	93	Tools	110
Brake Shoes	33	Engine Gears	64	Heaters	80	Rocker Arms	95	Top Deck Kits	50
Brush Carbon	34	Engine Parts	58-60	HLP Units	57	Roller Wheel Bearings	85-86	Traction Motor	111-117
Brushholder	35	Engine Protector	64	Horn Covers	80	Roots Blowers	94	Traction Motor Cables	119
Bulbs	35	Engines	55-57	Hose Air	81-82	Safety Line	96-99	Traction Motor Covers	120
Bulbs - Smart LED	36	Exhaust Products	66-67	Hose Sand	83	Sand Nozzles	96	Treads	122
Bumper Cab - Safety Head	34	Fan Cooling	72	Housings	83	Seals	65	Turbocharger	121
Cable 27 Pin MU	38	Fan Grid	72	Injectors	84	Seats	100	U Tubes	122
Cabs	37	Fasteners	68	Journal Box - Hyatt	85	Shims/Spacers	104	Water Pump	62
Card Holders	38	Filter - Air Line	72	Latch	87	Shock Absorbers, Snubbers	101	Wear Parts	122-123
Center Plates & Bowl Liner	47	Filters (Air and Fuel)	69-70	Levers - Hangers	87	Slack Adjuster	100	Wheel Sets	123
Chemicals Bio Friendly	39-46	Flex Filter Kit	71	Mirrors	91	Snow Plow	103	Wiper Motor, Arms & Blades	124

 **Disclaimer** *See Back Cover for Full Disclaimer.





"Uniting, Innovation, Engineering, Manufacturing and Distribution"

The purpose of this section is to show the wide offering of Products that have been Enhanced for the sole purpose of offering a customer a better product with Cost Savings , Reliability and Quality in mind. This section represents a sampling of our broad line and please feel free to visit our website to view the latest In design and technology.

PowerLok Oil & Grease Filled GearCases PowerLok Combination Oil/Grease Filled GearCases

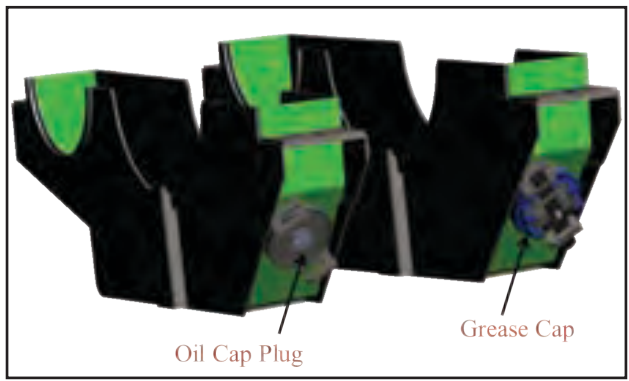
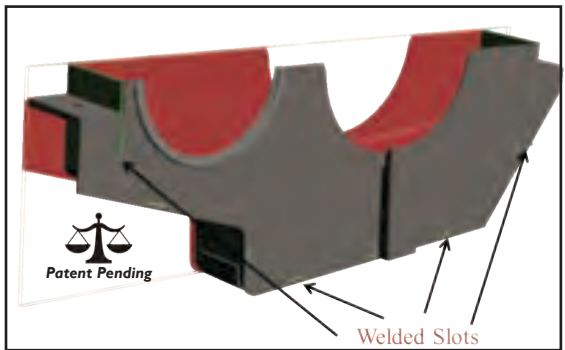

Tab and Slot Design

- 100% Slot Alignment For Better Fit and Operation
- Strengthens the Seams for **Heavy Impact Resistance**
- More Welding Points **Improved Integrity and Strength**
- CNC Robotic Welder Provides Stronger Welds vs. That of Contemporary Welds
- CNC Robotic Welder Provides Less Heat Which Lowers Fatigue Typically Found on Contemporary Welds
- ***Patent Design** - Mechanical and Electro Mechanical

Dual Cap Purpose

- Cap Drilled and Pinned to Prevent Improper Use

Enhanced Strength Patented Design Drastically Reduces Derailment Damage

Benefits

- Full Line of **PowerLok Oil & Grease GearCases**
- Less Inventory - Offering Both Designs
- **New Combination Oil & Grease GearCases**
AND
Original Design Oil Or Grease GearCases
- Reduction in Hazard Material Spills
- Reduction in Down Time Due to Small Derailments
- Increased Reliability and Service Life
 - **Our New CNC Robotic Welder provides stronger welds vs. that of contemporary welds**
 - **Our New CNC Robotic Welder provides less heat which lowers fatigue typically found on contemporary welds**

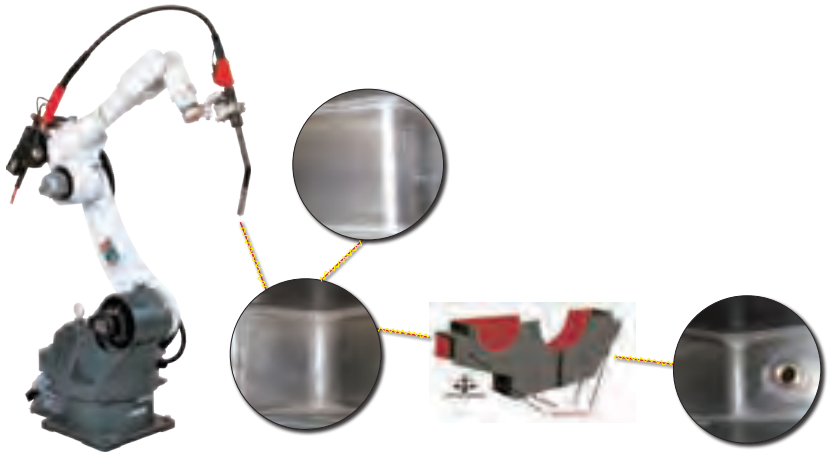

We Also Offer Original Design Grease or Oil GearCases - PLOCK Series - Call Our Team for Pricing and Availability!



Safety FRA Halogen Injury & Shatter Protection

NEW



Teflon Clear Coat Protection

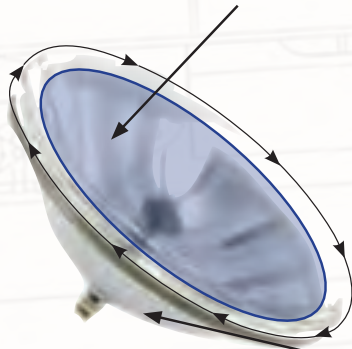

NEW FRA Halogen Safety Bulb

Replaces OEM references:

- **200PAR56**
- **350PAR56**
- **8156001**
- **6961711**
- **41A210466P1**
- **40150802**

**Proven Aviation Technology*

**Keeps Debris in the Housing*

Product Description

PowerRail Distribution Incorporated is pleased to offer the New “FRA Safety Halogen” Shatter Resistant Teflon Clear Coat Halogen PAR56. Our Third Generation safety bulb offers a “Teflon Clear Coat” layer of protection should the bulb break. When bulb breakage occurs, virtually all of the debris will remain inside the protective coating. These bulbs provide the ultimate protection in the event of impact, accidental dropping or thermal shock. It is designed for high temperature use (up to 500° F - 260° C). This technology offers reliability, longevity, reduced maintenance costs and is widely used in the Aviation Industry for its resistance to extreme climatic and vibration conditions which result in short life expectancy and frequent lamp change-outs.

In coupling Safety Protection with Long Life 200,000 Candela Output Performance, the bulb meets all FRA requirements and offers the Railroad Industry the latest technology in Halogen design and reliability.

Advantages:

- **Rated life up to 4,000 hours vs. 500 hours for incandescent bulb.***
- **200,000 Candela 350 Watt output Ditchlight (50 watt energy savings).**
- **200,000 Candela 200 Watt output Headlight**
- **Teflon coated glass to protect against shatter injury**
- **Superior filament design and support for superior reliability**

PowerRail Part Number

FRA200PAR56-SAFETY - FRA350PAR56-SAFETY

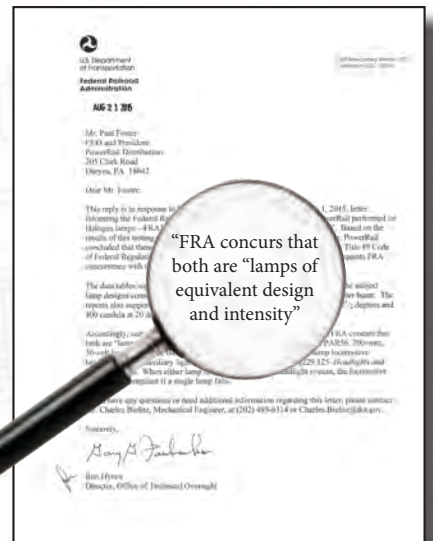



Smart LED RS50A19LED-AAR-6W



Replaces OEM references:

- 25A19 • 8090358
- 50A19 • 8094886
- 8080404 • 41A210382P2

PowerRail Distribution Company is pleased to offer the New "SMART LED" LED Bulb which Meets **New AAR Spec S-5515**.

This 6 Watt LED utilizes the Latest in **CREE LED** Technology that truly gives a total 270 to 320 Degree Beam Spread vs. Typical 180 Spread and 545 Lumens High Clean Output Brightness.

Besides offering a true cost savings LED, this bulb replaces (2) Two SKU's typically used in the rail industry.

LED Advantages:

- Rated Life 50,000 Hours vs. 1,000 of Standard Bulb. (50 to 1 Life)
- Reduced Generator Voltage Draw provides Fuel Savings
- No EMI Interference
- Reverse Polarity Protected
- Operates on Voltage Range of 50 Vdc to 80Vdc
- No Filaments or Glass to Break (Enhanced Protective Globe).
- Reduced Labor and Maintenance Labor Costs.
- Eliminates FRA Infringements Associate With Standard Bulbs.
- Bulb does NOT operate on AC Voltage
- TOTALLY SEALED with Heat Sink.



Other Related Technology Bulbs



SLS30S11 LED

<i>PowerRail Ref.#</i>	<i>Description</i>	<i>Style</i>
GE 44LED	2 Watt 8 Volt	LED
GE 1828LED	.8 Watts 37 Volt	LED
GE 1866LED	25 Watt 6.3 Volt	LED
SLS30S11LED (8190621)	30 Watt 75 Volt.	LED



POWERRAIL ENHANCEMENTS



ENHANCEMENT E8287294LED Lamp Holder - Flat or Domed



- Long Life LED Light Lasting Up To 100,000 Hours
- Multiple Colors Available To Choose From Including Amber, Blue, Green, Red, and White.
- Designed For Durability
- Polycarbonate Lens

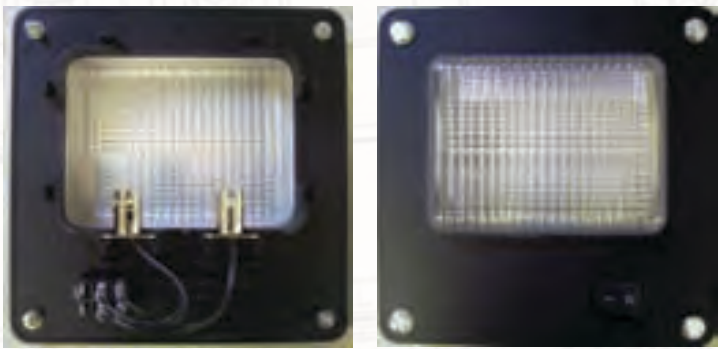

PowerRail Part
E9096838 Single Lamp - E9502221 Dual Lamp
OR
Enhanced Design
E9502221PRD Dual Lamp with
One or Both Bulbs On Off Option

ENHANCEMENT PRD16184541 6-Button Switch



Old Style

New Style

- This System was Designed to Meet the Vibration and Electrical Requirements of Newer Generation Locomotives Which Utilizes Electronic/Computer Enhanced Switches for Reliability.
- The Original OEM Reference 8484375 uses Mechanical Style Switches with Resistors..
- Exact Terminals ***Replaces OEM Ref# 8484375**
- Exact Drop In
- Sealed Unit
- Custom Silk Screen Button Labels



SLS30S11LED - 100,000 Life Hours
Full 360 Degree Viewing Angle



30S11 Standard Filament Style
30S11PREMIUM Long Life Filament Style



41A205337ABP2
LED Walkway Lights





Universal Ditch Light Housing

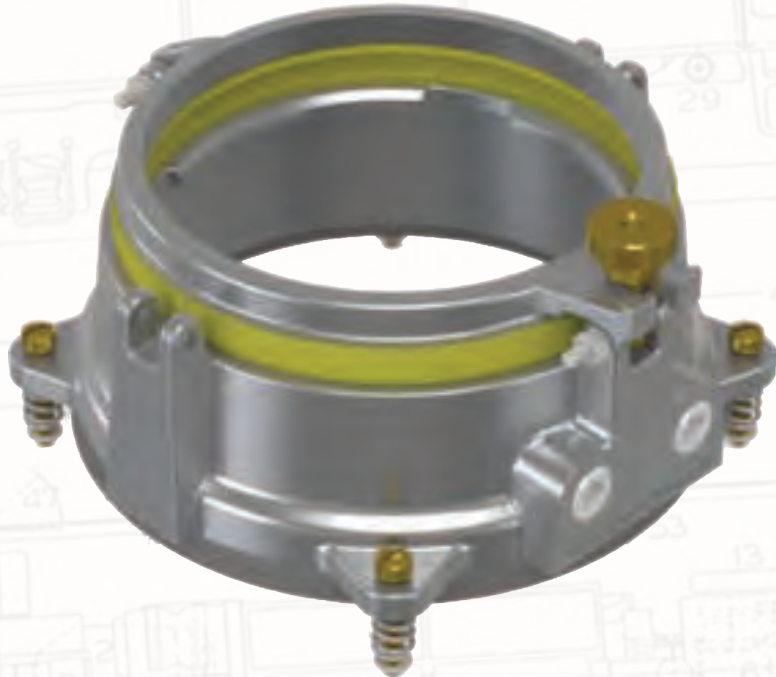

NEW

We also Offer the Ditch Light Housing OEM References 41B549606P1 and 41B549606P3



PowerRail PRD16184911

Universal Ditch Light Housing - Replaces many SKU's

- 8650814 / 40043668 - 2 Position Door Latch Flush Mount
- 40052369 / 40069142 - 4 Position Door Latch with Flush Mount

Benefits:

- Dual Mount - Flush or Conduit from Bottom (2) 1/4" NPT Mounts
- (4) Four Position Door Latch
- Reduction in Inventory
- High Quality Casting
- High Temperature Silicone E10610987 Gasket Included



We also Offer Fabricated Light Housings



POWERRAIL ENHANCEMENTS



ENHANCEMENT
Oil Cap



- Redesigned Location and Seal Material to Stop Leaks
- Seal Repositioned under Head
- Upgrade YellowSeal™ O Ring

E9333024	3/4" Yellow
E9324109	1" White
G41A2385 34P1	3/4" White

ENHANCEMENT
8004613PRD Polycarbonate Bowl

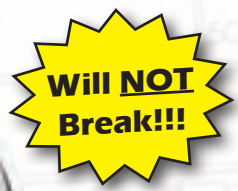

- Safety Enhancement **WILL NOT SHATTER** (like glass)
- Exceeds OEM Specifications
- Polycarbonate Material
- High Heat Applications

ENHANCEMENT
8104055PRD Gasket Fuel Bowl Site Glass



- Genuine Viton® Seal Compounded For Diesel Fuel
- Can Run At 400°F Constant
 - Easy To Install, Conforms To Fuel Sight Bowl
 - Long Life Cycle Without Degrading

Note: We Also Offer E8361381 Glass Bowl and E8104667 Clevis

ENHANCEMENT
PRD16184502 Oil Sampling Valve
1/4 NPT thread



POWERRAIL ENHANCEMENTS

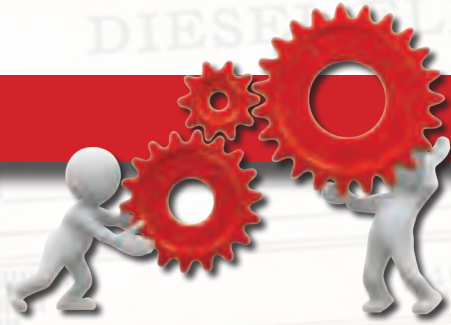

PowerRail Distribution Inc. is pleased to offer our New Generation premium gasket material to stop **ALL leaks in all Locomotive and Marine applications.**

C-Swell YellowSeal™ gasket material is an OEM approved material which was precision enhanced to offer a Controlled Swell. This controlled swell expands when it comes in contact with the media it is sealing. The controlled swell allows the gasket material to fill voids and imperfections on component flanges and sealing surfaces, and literally will stop leaks, even in the most demanding applications.

C-Swell YellowSeal™ is a highly compressed, solvent free, Hydro-Fused industrial OEM gasket material manufactured exclusively for the Rail and Marine industries. Documented ASTM testing has confirmed that **C-Swell YellowSeal™** material offers excellent bolt torque retention, crush resistance, and resist extrusion over a longer period of time than existing competing gasket materials. Additionally, **C-Swell** offers the end user a material that has a long shelf life.

C-Swell YellowSeal™ gaskets will stop leaks, reduce maintenance cost and most of all; lead us to cleaner and safer locomotives for us and our environment.

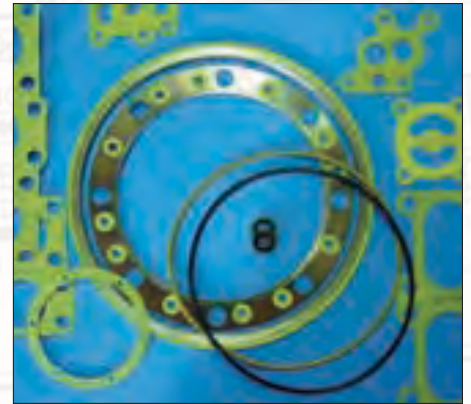
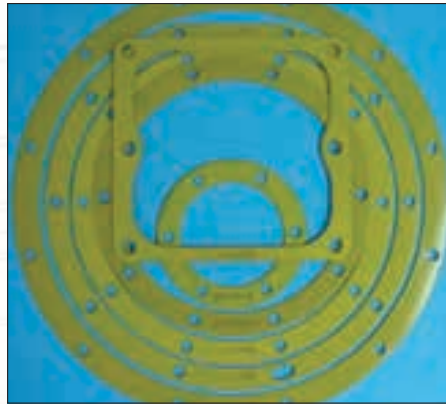
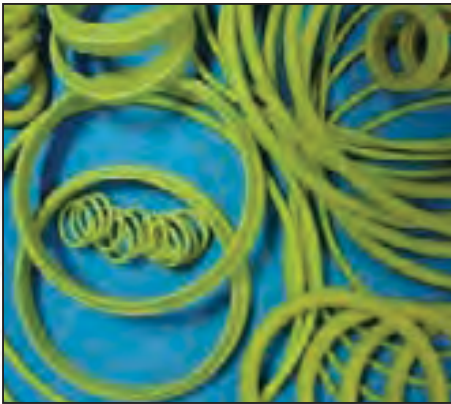

ASTM F-1574 Compressive Strength
1 Minute Dwell Time @ 150° C

Identification	Control	48.1 MPa 10,800 psi	66.2 MPa 12,500 psi	104.4 MPa 15,000 psi	120.1 MPa 17,500 psi	137.9 MPa 20,000 psi
Master Packing (3017-05.8 inch)						
Crush Resistance		11%	17%	28%	36%	48%
Area Increase @ Compressive 10" (3017-05.8 inch)						
Area Increase %		18%	31%	45%	67%	87%

ASTM F-1574, is used to determine the compressive strength characteristics or crush-extrusion resistance of various gasket materials at an elevated temperature. All specimens shown below have been tested 300°F.

ASTM F-1574 Standard states in Significance and Use 4.1 "The compressive strength or crush-extrusion resistance of a gasket material is a major factor with regard to the selection of a given material for use in a

particular sealing application. The significance of the test method is based, in part, on the assumption that material, once it has been crushed or extruded, will no longer function as effectively as a seal. Two or more materials can be compared to determine differences in their resistance to compressive stress."



POWERRAIL ENHANCEMENTS



ENHANCEMENT Marman Seals - NEW VPS YellowSeal™ Material Technology!!!

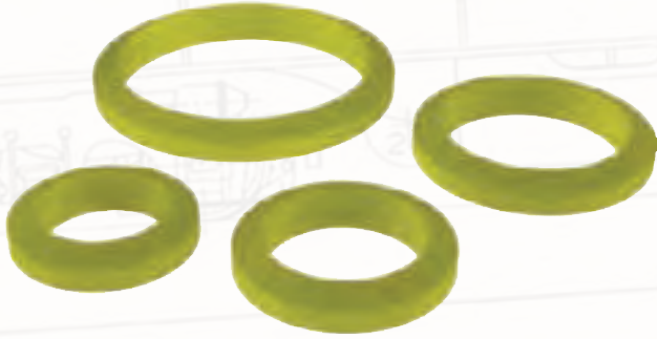

- NEW CG2F Viton® Power Seal (VPS) offers Extended Life
- Viton F is Superior for Oil & Fuel Contamination
- Designed with VPS YellowSeal™ Material

SEE PAGE 65 FOR MARMAN SEALS

ENHANCEMENT YellowSeal™ Head to Liner Gasket



- 400 Series Stainless - Low Expansion Rate for Extreme Heat
- NON Copper Coated - Eliminates Oil Contamination
- Proprietary "F" Family High Grade Viton® VPS YellowSeal™
- Outperforms OEM Material for Durability & Life
- Collared I.D. Sealing Ring Stops Fractures
- Operating Temperatures Range From -30°F to 400°F
- Class 1 Approvals

*Replaces 8476400/9561067/40067459/40099569

ENHANCEMENT Head Seat Ring Technology



- Meets or Exceeds OEM Specifications on Metal Centrifugal Casting
- Enhanced Proprietary Viton® Compound
- Enhanced/Redesigned VPS Viton® profile for Ultimate Sealing
- Field Reports of reduced and/or elimination of "Engine Souping"

ENHANCEMENT YellowSeal™ - Fuel Line Gasket



- VPS YellowSeal™ Material for both Oil & Fuel Contamination
- Stop Fuel Leaks at the Injector and Manifold Connections

PowerRail Part# PRD16184063



POWERRAIL ENHANCEMENTS



ENHANCEMENT Expansion Joints



- 6 Baffle Design reduces Harmonics that cause Fatigue
- 321 Stainless Steel
- 3 Ply Construction for Long Life
- Hydraulic Tested for Ensured Exhaust Flow
- Frequency Tested for True Performance

Replaces 8408985 & 8408987

ENHANCEMENT Water Elbow & Seal

Part# E40110618 Seal for E8414444 Elbow

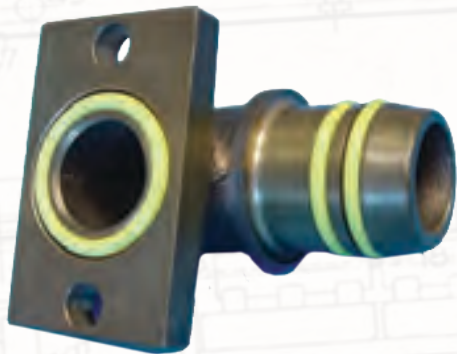

- Stops Water Leaks Associated with Old Style O Rings
- YellowSeal™ Material for Both Oil & Fuel Contamination
- Class 1 Approved

Replaces Old Ref #9317972

ENHANCEMENT MODIFIED Expansion Joints Gaskets **THERMASEAL for High Heat**



- Increased Thickness for INCREASED Bolt Retention
- Special Graphite Filled with Proprietary filler to increase working temperatures of approx. 1250 Degree F.

Replaces 40026936 10" Expansion Joint

40026937 14" Expansion Joint

40055466 Exhaust Stack

40026939 Expansion Joint to Turbo

9571663 Exhaust Cover 710

PowerRail Enhanced Big Foot for all TOP DECK COVERS



E9087073BIG-CG2 - 8 & 16 Cyl Round Corner

E9087074BIG-CG2 - 12 Cyl Round Corner

E9087072BIG-CG2 - 20 Cyl Round Corner

BIG FOOT™ silicone extrusion sits higher than any previous seals made for the upper deck covers.

- BIG FOOT™ is easier to install into the groove with a slightly reduced profile that saves on both maintenance labor and downtime.
- Compresses without "squirm" around the corners - insuring a tighter seal.



POWERRAIL

CREATIVE INNOVATIONS ... CONTINUING TRADITION

POWERRAIL ENHANCEMENTS



ENHANCEMENT Cylinder Test Valves



OEM Ref#
8048880
40036607

- Class 1 Approved Design
- Solid One Piece Machined Nut in lieu of Welded Nut
- Designed for 567 – 645 and 710 Series Engines
- Utilizes Standard 5/8" Socket 6 or 12 Point

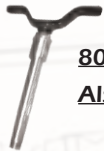

8048880 T-Handle Design
Also Available

ENHANCEMENT

28 - 90 Volt DC Electronic Bell
PowerRail Part# EBELL82 with 30 Ft Harness



- No Mechanical Wear Parts and NO Air Leaks
- Sound level: 85dB(A) at 50ft
- Adjustable Intensity and Loudness
- Weather Resistant Speaker
- 125 Rings per Minute
- Operating temperatures range from -40°F to 158°F

ENHANCEMENT E8158536 Door Latch Assembly



- Improved Lever Design for Smooth Operation
- Advanced Painting Method for Extended Life
- Passenger & Class 1 Approved
- We Offer Full Line of Carbody Parts
 - ✓ Treads
 - ✓ Handrails
 - ✓ Grab Irons
 - ✓ Hinges
 - ✓ Door Latches
 - ✓ Door Panels



ENHANCEMENT



Inverter

COMPLETE System
Part# PRD16184487
*Gasket System Included
*Requires Wiring

- Heater & Air Conditioner for Switchers and Road Units. Durable, Competitively Priced and Easy Installation.
- 14" High 86 Lb A/C Low Profile
- 13,500 BTU Air Conditioner 13 Amp
- 5,600 BTU Heat Pump 16 Amp
- 2 Speed with Thermostat
- Center Cooling and Oscillating Rear Vent
- 74 Volt DC Inverter runs 85% Efficient with Extra Power for other 110 Volt Accessories
- Handles High Inrush Loads
- Extensive Electrical Protection





POWERRAIL ENHANCEMENTS



ENHANCEMENT

Hyatt & Conversion Box Lateral Pad - E9539431 & PRD16184305



E9539431

E9539431 Lateral Pad for all Hyatt and Generic Conversion Boxes for Locomotive axle. E9539431 meets or exceeds all specifications.



PRD16184305
1/8" Thinner for Ease of Installation

PRD16184305 Manufactured 1/8" lower to ease installation due to restraints and tight fits. This product also meets or exceeds all specifications.

***WE OFFER NEW GG BOXES!!!**

New E9539650 EMD Style GG Boxes

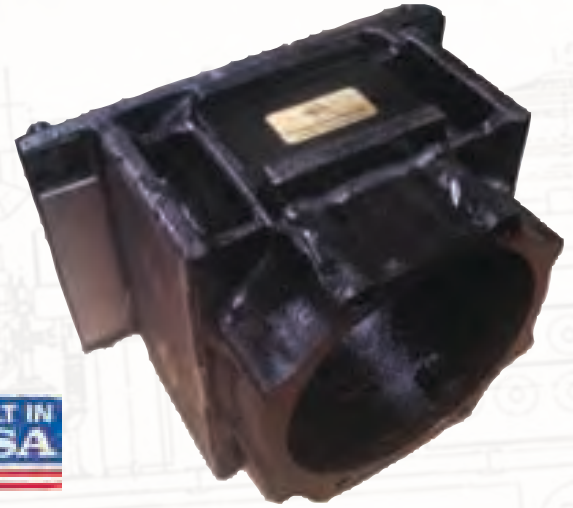
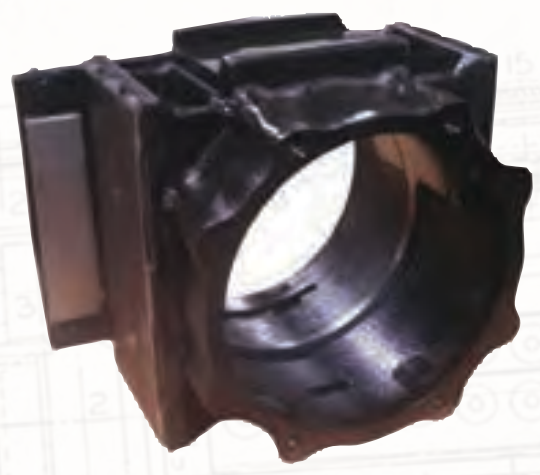



PowerRail Flexi-Filter



PowerRail Distribution Inc. is dedicated to provide alternate solutions to the Rail Road industry at competitive pricing. The newest addition to our family is "Flexi-Filter Line" which offers High Quality and Proven Performance.

- Benefits Include -

- Purchase in **Any Quantity** at the Case Price which Eliminates Overstock and Reduces Inventory Cost \$\$\$
- **Customize Kits** Available Dedicated By Road Unit Number which eliminates need to stock any filters AT ALL.

PLEASE SEE PAGE 71 FOR ALL INFORMATION



POWERRAIL ENHANCEMENTS



Security Fastener System

Systems Available for K5LA or K3LA Air Horns

PowerRail has developed a special Security Fastener System that has multiple uses on a locomotive.

The system is used when extra secure fastening is required. These special fasteners have an anti-vibration effect for extra secure fastening.

An example of a typical application is for airchimes to prevent costly theft.



Our system replaces existing nuts and bolts. A special proprietary key, which is made exclusively for the railroad, secures the nuts and bolts in place

K3 Air Horn Kit PRD16184836 - K5 Air Horn Kit PRD16184480

<p>A smooth head prevents wrenches from removing. Additionally, the head is oversized to spread its compressive load</p>	<p>The bottom of the head is serrated to latch onto a surface with incredible strength</p>	<p>Example of how well the fastener latches to the surface of the locomotive</p>	<p>The internal drive nut is cone shaped to resist vice grips and a compression ring fastens and assures security</p>

PLEASE SEE PAGE 29 FOR AIR HORNS



POWERRAIL ENHANCEMENTS



ENHANCEMENT

New Unit Exchange — "New-UX™"

PowerRail is pleased to offer our customers the opportunity to upgrade their fleet with **100% New Product** in exchange for older cores. This will enable the end user to have True Reliability and Dependability vs. cores that are of lesser performance.

This Registered Trademark program demonstrates PowerRail's strive for continued Quality, Performance, Price and Service.



POWERRAIL

CREATIVE INNOVATIONS ... CONTINUING TRADITION



*"Uniting Innovation, Engineering,
Manufacturing and Distribution"*



AIR BRAKE

Complete line of 26L Air Brake New and Unit Exchange



NEW YORK AIR BRAKE 

OEM Ref. #

- 731033 / 93840
- 733328 / 97368
- 739010 / 558534
- 739007 / 558987
- 735742 / 557173
- 735743 / 557924
- 739006 / 557395
- 739000 / 557237
- 743490 / 562872
- 740408 / 562614
- 735432 / 554061
- 733328 / 97368

Portion Mounting Gaskets

- H5 Relay Air Valve
- J-1 Relay Valve
- F-1 Selector Valve
- MU-2A Valve
- Quick Rel. Valve (26F)
- Service Portion (26F)
- 26C Brake Valve
- 26L Brake Valve
- P2A Appl. Brake Valve
- A-1 Charge. Cut-Off Valve
- J-1.4-14 & J-1.6-16 Relay
- J-1 Relay Valve



**PRD16185288 - 26L Air Brake
*UNIT EXCHANGE IN STOCK***



Packing Cup Replacements

OEM Ref. # Packing Cups

- 524478 2" Packing Cup
- 501863 3 1/2" Packing Cup
- 513750 5" Packing Cup
- 501530 6" Packing Cup
- 96556 8" Packing Cup
- 506957 9" Packing Cup
- 94800 10" Packing Cup
- 506018 11" Packing Cup
- 99882 12" Packing Cup



Single Car Tester



704609/572869/660999/
8433293 - Angle Cock



3N1 Freight Valve



Air Hose - See Page 81-83



Brake Shoes - See Page 33





*"Uniting Innovation, Engineering,
Manufacturing and Distribution"*



AIR CONDITIONER

Combination Heater & Air Conditioner for Switchers and Road Units. Extremely Durable, Competitively Priced & Easy Installation.



**COMPLETE System
Part# PRD16184457 SYSTEM**

- 14" High 86 lbs. A/C Low Profile
- 13,500 BTU Air Conditioner 13 Amp
- 5,600 BTU Heat Pump 16 Amp
- 2 Speed with Thermostat
- Center Cooling and Oscillating Rear Vent

Heavy Duty Inverter



AIR HORNS

Complete Line Air Horns, Air Horn Covers and All Related Parts Manufactured by



<u>PowerRail Ref #</u>	<u>Description</u>
K1LAR	1 Chime
K3LR2	3 Chime Regular
K5LAR24	5 Chime Regular
WH-SA-110	Diaphragm Kit 3 Chime
WH-SA-112	Diaphragm Kit 5 Chime
E8185843	Rubber Mount for Roof



We carry A Full Line of Horn Valves and other related parts.

AXLE GENERATORS & SENSORS, SPEED & TEMPERATURE

Complete Line of Axle Alternators, Transducers and Sensors.

PowerRail P/N

Description

E9319132	Axle Alternator
E40063597	Sensor SD70
E40121230	Sensor Speed SD70
E40021658	Sensor Temperature
E40029233	Sensor Temperature
E40134844	Sensor Temperature
E40063567	Sensor Oil
E40081692	Sensor Radar K Band
G17MM24F1	Axle Alternator
G17MM24AF1	Axle Alternator
G17MM102F3	Traction Sensor
G17MM57H401	Speed Sensor
G17MM103	Traction Sensor
G41A296328AAP	Sensor Temperature



PowerRail Electronics offers a full line of R&R & Unit Exchange



POWERRAIL
CREATIVE INNOVATIONS ... CONTINUING TRADITION



*“Uniting Innovation, Engineering,
Manufacturing and Distribution”*



ALTERNATORS

Complete Line of **True Blue™** Main Alternators & Exciters Re-Manufactured
by **PowerRail – Independent Electric**



OEM	OEM Ref. #
EMD	AR10
EMD	AR11
EMD	AR15
EMD	AR16
EMD	AR17
EMD	TA17
EMD	AR20
GE	GTA11
GE	GTA24

Other Related Items

Diode Negative	E40029131
Diode Positive	E40029132
Diode Boot AR10	E8378316
Diode Socket	E8361524
Diode Positive AR20	E40032602
Diode Negative AR20	E40032603
Diode Boot AR20	E40048214
Spring Clip AR10	E8434285
Spring Clip D14	E8434286
Spring Clip TA17	E40132923
Rectifier Bank 2000V	E9084995
Brushholder D14	E8413188
Brushholder TA17	E8413189
Glass Oval AR10 6" x 12.13/16"	E8167423
Weather-stripping	E8489788
Glass Inspection Air Box	E8345780
Glass Diode Inspection	E8433679
Weather-Stripping	E8167425
Filler	E8169637
Brushholder Clip U Shape	E8330890
Slip Ring Assy	E8345866
AR10 Closure	E8390572

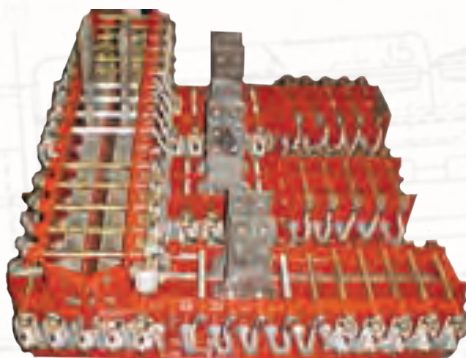

POWERRAIL

CREATIVE INNOVATIONS ... CONTINUING TRADITION



**"Uniting Innovation, Engineering,
Manufacturing and Distribution"**



AIR BRAKE - BALL VALVES

Air Brake Ball Valves for Locomotives



- Teflon Seats
- Chrome Plated Balls
- Stainless Springs
- Zinc Plated Handles
- Self Tapped Bodies

OEM Ref#	OEM Ref#	Pipe Size	Porting	Vent	Position Open/Closed	Plain Locking	Handle Length
8454218	308127	3/4"	Standard	7/32" B	90° 0°	Plain	1 3/4"
8452907	307898	3/8"	Full	5/64" B	0° 9 0°	Plain	3 3/4"
8363508	307994	1 1/4"	Full	-	180° 90°	Locking	7 1/4"
8458815	308136	1 1/2"	Standard	-	0° 270°	Wrench	-
8354227	307985	1 1/4"	Standard	-	0° 90°	Plain	4"
8409024	307918	1 1/2"	Standard	-	0° 90°	Locking	5 1/8"
8351610	307936	1/2"	Full	-	90° 0°	Locking	3 1/8"
8419531	307974	1/2"	Full	3/32" B	90° 0°	Locking	3 1/8"
8363655	307937	3/4"	Full	-	90° 0°	Locking	3 1/8"
8351609	307938	1"	Full	-	90° 0°	Locking	5 1/8"
9332599	581236	1 1/4"	Full	1/8" B	90° 0°	Locking	5 1/8"
8412325	307976	1"	Full	1/8" B-NPT	90° 0°	Locking	5 1/8"
8423393	307907	3/4"	Standard	1/4" B-NPT	90° 0°	Locking	3 1/8"
8467908	307975	3/4"	Full	3/32" B	90° 0°	Locking	3 1/8"
8451783	308114	1"	Full	1/8" B	0° 90°	Locking	5 1/8"
8365217	308014	1 1/4"	Full	-	270° 0°	Plain	5 13/16"
8351608	307958	3/8"	Full	-	90° 0°	Plain	1 1/2"
8463756	307986	1 1/2"	Standard	-	0° 90°	Plain	4"
10538664	307966	3/8"	Full	-	0° 90°	Locking Sealed	3 1/8"
9569220	572465	3/4"	Full	-	90° 0°	Plain	4 7/16"
8365777		1/2"	Standard	-	0° 90°	Plain	3 3/4"
40014305	572474	1 1/4"	Full	-	90° 0°	Locking	5 1/8"

BATTERIES

Complete Line of Locomotive Switcher
and Road Batteries Manufactured by

Surrette Battery



QuickCharge Model 64V/25A
115V or 230 V Battery Charger

LCD Display Amps & Volts

Set Internal Switch for AGM,

Deep Cell, Gels & Starting Batteries

* **Built in SAFETY** — Cables not Live
until connected to battery!!!!

PowerRail # 20 HR 8 HR Length Width Height Wgt.

8 Volt 4 Cell Series

P8HHG31PR	344	282	27	8	11 7/8	167
P8EHG31PR	410	336	27	8	12 3/4	178
P8NS23PR	430	352	28 1/4	8 1/4	18 1/4	242
P8CH23PR	582	477	28 1/4	8 1/4	18 1/4	256
P8NS33PR	625	512	28 1/4	11 1/4	18 1/4	352
P8CH33PR	846	694	28 1/4	11 1/4	18 1/4	414

32 Volt 16 Cell Series Unitized Series

P16CH25PR	635	521	33 2/3	27	20 1/2	1238
P16CH33PR	846	694	43	27	20	1609

3 Year Warranty
36 Lbs 8.5 x 10

QuickCharge Battery Chargers

OP6425	64V/25A 117V 60HZ
OP3225	32V/25A 117V 60HZ

Other Related Parts

E8197509	Terminal Lug Battery
E8211044	Terminal Lug Battery
E40015058	Bolt Kit
JUMPERRR31	Cable Jumper Kit

See Car Body - Battery Grating on page 54



POWERRAIL
CREATIVE INNOVATIONS ... CONTINUING TRADITION



**“Uniting Innovation, Engineering,
Manufacturing and Distribution”**



BEARINGS

Complete Line of Engine Bearings
Manufactured by **Miba/Federal**



OEM	OEM Ref. #	Description
EMD	8028006	Thrust Bearing Collar
EMD	8028419	Thrust Bearing Collar
EMD	8029461	Bushing
EMD	8029491	Oil Pump Bushing
EMD	8068624	Floating Bushing
EMD	8071176	Cam Bearing
EMD	8136114	Con Rod Bearing Lower
EMD	8237900	Bearing Front Bracket
EMD	8253825	Bearing Rear Bracket
EMD	8341192	Insert Roots Blown
EMD	8354118	Con Rod Bearing Upper
EMD	8361565	Insert Carrier
EMD	8452186	16 Cyl. Upper Main Kit
EMD	8452210	16 Cyl. Lower Main Kit
EMD	8455081	12 Cyl. Upper Main Kit
EMD	8455083	12 Cyl. Lower Main Kit
EMD	8455665	Rear Lower Main
EMD	8455666	Front & Int. Lower Main
EMD	8455667	Center Lower Main
EMD	8455668	Center Lower Main
EMD	8455844	Rear Upper Main
EMD	8455850	Center Upper Main
EMD	8455856	Center Upper Main
EMD	8455862	Front & Int. Upper Main
EMD	9571921	Rocker Arm Bushing
GE	114X1150	Lower Grooveless
GE	114X1103-1	Upper Grooved Main
GE	114X1111-4	Thrust Washer
GE	114X1127-3	Thrust Washer
GE	116X1184	EFI Large Cam
GE	117X1028-2	Articulated Rod
GE	117X1045-2	Upper & Lower Con Rod
GE	117X1050-1	Grooveless Con Rod
GE	117X1070	Upper Grooveless Con Rod
GE	117X1075	Lower Grooveless Con Rod
GE	142X1019	Standard Piston Pin Bushing
GE	142X1042	Piston Pin Bush .30 oversize

BRAKE HANDLES

Complete Line of Brake & Reverser Handles.
Manufactured in Steel, Bronze and
New Safety Plastic Versions

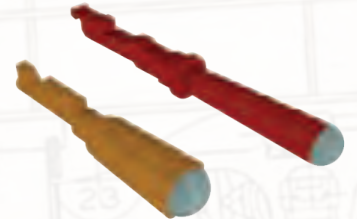

Safety Handles - Color Coded and Glow in the Dark!!!

OEM	PowerRail#	Description
EMD	E8251349SAFETY	Independent Brake
EMD	E8204980SAFETY	Reverser Handle Safety
EMD	E8269348	Independent Brake - Offset
EMD	E8495188	Independent Brake - Offset
EMD	E9550359BLK	26C Automatic Plastic Safety Version
EMD	E9550359	26C Automatic Steel Construction
GE	G84B512767P1	Reverser Handle
GE	G41B557247G1	Reverser Handle

BRAKE PRODUCTS

Complete Line of Brake Head,
Keys, Pins & Bushings for
Locomotive Trucks.



PowerRail P/N	Description	Comment
E8151703	Brake Head	OE Style
E8160059	Brake Head	GP OE
E8160060	Brake Head	OE Style
E8235906	Brake Head	OE Style
E8242785	Brake Head	SW Trucks
E8385297	Brake Head	OE or Canted Style
E8388332	Brake Head	OE or Canted Style
G41A210602P2	Brake Shoe Key	13"
E8101930	Brake Shoe Key	14"
E9501303	Brake Shoe Key	15"
E8100136	Brake Shoe Key	16"
E8101977	Brake Shoe Key	20"



POWERRAIL

CREATIVE INNOVATIONS ... CONTINUING TRADITION



*“Uniting Innovation, Engineering,
Manufacturing and Distribution”*







BRAKE SHOES

Complete line of 26L Air Brake New and Unit Exchange



NEW YORK AIR BRAKE

Locomotive Brake Shoes	Shoe Length	Shoe Face Width	Face Design	Side Relief	Tie Plate	Taper	Rejection Lugs	RFP Alternative
H33 	14"	3"	Center Relief	Yes	Yes	No	High Friction Only	V330 V392
H43 	14"	3"	Full Face	Yes	No	45 End 5 Face	High Friction Only	N/A
H63 	18"	3"	Center Relief	Yes	No	No	High Friction Only	V188 V381
L35 	14"	3"	Center Relief	Yes	No	No	Low Friction Only	V553 V381
L63 	18"	3"	Center Relief	Yes	Yes	No	Low Friction Only	V555 V556 V575

We offer both a complete line of High and Low Friction





**"Uniting Innovation, Engineering,
Manufacturing and Distribution"**



BRAKES - HANDWHEEL & RATCHET

Complete Line of Wheel and Ratchet
Style Handbrakes



PowerRail	Model	Dia	O.A.	B.H. LF	End Link
E6948643	850-7	22"	6'-5"	5'-11"	18
E6946788	850-7	22"	14'-4"	13'-10"	1091-A
E6938301	850-7	16"	14'-0"	13'-6"	1091-A
E6948643	850-B	18"	6'-5"	5'-11"	1091-A
E6949785	850-C	22"	14'-10"	14'-4"	1091-A
E6942139	850-7	22"	15'-8"	15'-2"	1091-A
E6939749	850-7	20"	15'-8"	15'-2"	1091-A
E6955210	850-C	22"	6'-5"	5'-11"	1091-A
E6949199	850-B	18"	6'-5"	5'-11"	1091-A
E6953126	850-C	18"	15'-4"	14'-10"	1091-A
E9093520	850-7	22"	11'-6"	11'-0"	1091-A
E9097828	850-7	18"	11'-6"	11'-0"	1091-A
E9501206	850-7	20"	11'-1"	10'-7"	1091-A
E9322184	850-7	20"	13'-0"	12'-6"	1091-A
E9507177	850-7	20"	10'-11"	10'-5"	1091-A
E40019843	850-B	22"	6'-5"	5'-11"	1091-A
E10576362	850-B	22"	35'-4"	34'-10"	1091-A
E6969970	850-B	22"	33'-4"	32'-10"	1091-A
E40037149	850-1	22"	6'-6"	7'-0"	18

O.A.—Overall Chain Length

B.H. LF—Chain Length Below Hand Lever Fulcrum

BUMPERS CAB - SAFETY HEAD

Complete Line of Cab Safety Bumper Protection

E10568293 13 1/4" Long	E40050919 14 1/4" Long
E10596355 23" Long	E40072060 16.56" Long
E10615556 Left side 8"	E40072097 11" Long
E10615560 8" Long	E40100014 22.154" Long
E10643171 17" Long	E40100015 18" Long
E10643172 8 1/4" Long	E40126589 14" Long
E10643173 15 1/4 Long	E40141486 4" Long
E10643249 18" Long	E9312193 Smoke Retardant
E10666194 17 Long	E9312229
E40047167 8" Long	E9321670 20 3/4" Long

*(Partial Listing of
Common Bumpers)



BRUSH CARBON

Complete Line of Premium
Carbon Brushes. Traction Motor
— Alternators Main and A
Generators Blowers, Heaters
and Fans



PowerRail P/N	Application	PowerRail P/N	Application
E40034666	AR10	E8307806	D12-D25 Main Gen.
E6727520	Aux. Gen.	E8413190	D14/D16 Main Gen.
E9096661	Aux. Gen.	E8330994 - Old	D32
E9096992	Aux. Gen.	E8417868 - New	Main Gen.
E8271326	Aux. Gen. Grid Blower	E9322054 2 wafer	D27-D57 TM
E4996232	Aux. Gen.	E9322058 3 wafer	D77-D78 TM
G998X67	Fuel Pump	E40070976 5/8 x 2	With Insulation
G998X90	Fuel Pump	E40047198 3/4 x 1 1/2	D87 24/TM D87 16/TM
G149X1011-1	Fuel Pump	E8078488	Fuel Pump
G149X1051	Fuel Pump	E9569980	Cab Heaters
G2X4460	Heater	E1906989	Starter
G6727520P1	Aux. Gen.	G41A330412P2	Alternator
G41A239329P2	GTA11 Alternator for Steel Ring	G41B537963P1	752E8 TM
G221F223P1	Fuel Pump	G41B535803P3	752AF & AG TM
G221F234P1	Fuel Pump	G149X1051-1	Cab Heater Motor

***Many Others Available**

Please call us for our Appendix of Part Numbers
Also Offer Full Line of Springs & Studs





**“Uniting Innovation, Engineering,
Manufacturing and Distribution”**



BRUSHHOLDERS

Complete Line Of New And Unit Exchange Brushholders



PowerRail P/N	Holder Application	Brush Size
E8084210	D12 D22 Main Generator	5/8 x 1 5/16
E8124419	D15 D25 Main Generator	5/8 x 1 5/16
E8331071	D14 D32 Main Generator	.842 x 1 5/16
E8338116	Spring Cell Brush Holder	
E8413188	D14 Alternator	3/8 x 3/4
E8413189	AR10/TA17 Slip Ring	1/2 x 1 1/4
E5551980	A7159 Ailiary	1 X 5/8
E5387140	A7159 Ailiary	5/8 x 1 3/4
E8174433	D29 Traction	5/8 x 1 3/4
E8290124	D31 Traction	5/8 x 1 3/4
E8417729	D57/D77/D78/D87 Traction Motor 16/Mtr	5/8 x 2
E9550251	D87B Traction 24/Mtr	.713 x 1 1/2
PowerRail P/N	Holder Application	Brush Size
G41B530658G1	GY19/GY27/GY50 Main Generators	1/2 X 1
G6733792G1	GT566/568/581/586/603 Main Generators	3/4 1 1/4
G334B746 G6732876	GT558 Main Generator	5/8 X 1 1/4
G41B531649 G41C633095	GTA22/24/25/26 Main Generator	3/4 X 1 3/4
G41B537170G1	GMG185A Alternator	3/4 X 1 3/4
G41C632667G1 G41C632667G6	GE752 Radial Traction Motor	3/4 X 2 1/4
G41C633771G1 G41C633771G3	GE752 Reaction Traction Motor	3/4 X 2 1/4

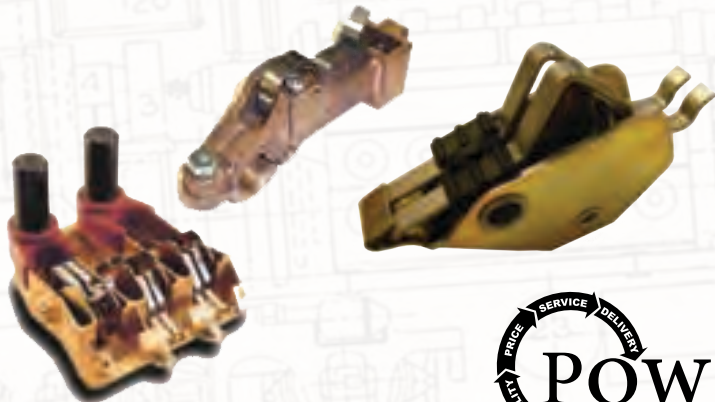

BULBS

Complete Line of Premium Grade Light Bulbs.
We offer a full line of Filament,
LED and New FRA Safety Halogen
and 50A19 Rough Service LED

PowerRail Ref.#	Description	Style
GE 44	2 Watt 6 Volt	Filament
GE 44LED	2 Watt 6 Volt	LED Dimmable
GE 1828	1.8 Watts 37 Volt	Filament
GE 1828LED	1.8 Watts 37 Volt	LED
GE 1866	.25 Watt 6.3 Volt	Filament
GE 1866LED	.25 Watt 6.3 Volt	LED
50A19 (8094886)	75 Volt 50 Watt Rough Service	Filament
50A19Premium	75 Volt 50 Watt	Filament
RS50A19LED AAR-6W (8094886)	75 Volt 6 Watt Rough Service Complies to AAR Standard S-5515	LED Totally Sealed
30S11 (8190621)	30 Watt 75V	Filament
SLS30S11LED (8190621)	30 Watt 75V	LED
200PAR56 (8156001)	32 Volt 200 Watt Headlight	Filament 200 Watt
 200PAR56FRA Safety (8156001)	32 Volt 250 Watt Headlight	Halogen 250 Watt FRA Approved
350PAR56 (6961771)	75 Volt 300 Watt Ditch Light	Filament 350 Watt
 350PAR56FRA Safety (6961771)	75 Volt 400 Watt Ditch Light	Halogen 400 Watt FRA Approved



POWERRAIL
CREATIVE INNOVATIONS ... CONTINUING TRADITION

See Pg. 15 for FRA Halogen Bulb



*“Uniting Innovation, Engineering,
Manufacturing and Distribution”*



FACILITY LIGHTING

PowerRail Distribution, being a leader in LED Technology for Freight and Passenger trains as well as Locomotives and cars, has unique low cost - high quality LED lights for office, warehouse, locomotive maintenance facilities and more. Contact us for a custom design to meet all of your needs.





*"Uniting Innovation, Engineering,
Manufacturing and Distribution"*



CABS

Complete Line of Regular & New Crash Worthiness Cabs, Frames and Fuel Tanks

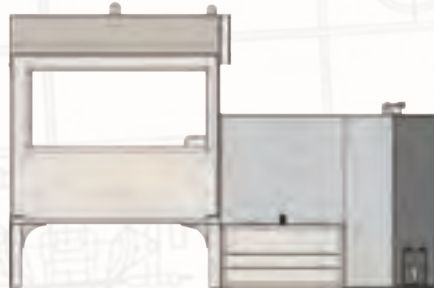

Cabs



Cab Door Assemblies



New Frames



Cab Stuffed with All Components



E8167296
Flame Arrestor Fuel Tank



Fuel Tanks - Standard & New Crash Worthiness

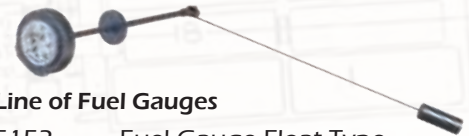

Full Line of Fuel Gauges

- 9515153 Fuel Gauge Float Type
3900 Gallons
- 9321144 Fuel Gauge Float Type
4000 Gallons
- 8438327 Fuel Gauge Side Mounted
4000 Gallons
- 40058437 Fuel Gauge Float Type
5000 Gallons SD70



E9334250
Awning Window

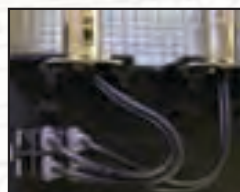

Modified Switch for
1 or 2 Lights



Cab Light

PowerRail Part#
E9096838 Single Lamp
and **E9502221** Dual Lamp
E9502221PRD Dual Lamp with One
or Both Bulbs On Off Option



SLS30S11 LED Bulb





*"Uniting Innovation, Engineering,
Manufacturing and Distribution"*



CABLE 27 PIN MU - RECEPTACLES & HANGERS

Complete Line of Premium MU Cables & Hangers



PowerRail P/N	Overall Length	Type
E8195546	5 Ft.	MU Cable
E8208511	7 1/2 Ft.	MU Cable
E8195547	8 Ft.	MU Cable
E8195548	9 Ft.	MU Cable
E8196711	11 Ft.	MU Cable
E8200922	Hanger 2 Piece Split w/Hook	
E9573822PRD	Hanger w/Hook Enhanced Long Life	
HR-50	Hanger Solid/Fixed	
PP16540	MU Wire Holder - Class 1 Style	

Note: Hangers add prefix C with Hook & Chain

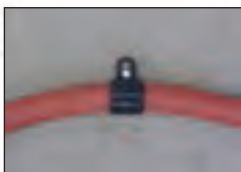
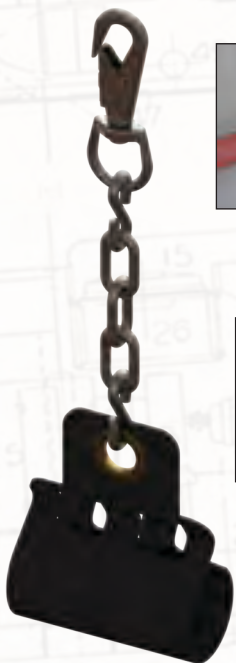

E820092



PP16540

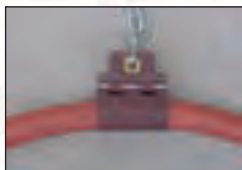

E9573822PRD

***Long Life
Heavy Duty
Rubber***

CARD HOLDERS
Complete Line of Card Holders

PowerRail P/N	Description	Comment
C90260	4 Slot	Holds Qty 4 6" x 9" Cards
C90227	Single Slot	11 1/2 x 13 1/2" Single Card 6 Holt Mount
C90262	Single Slot	3 1/2"x 4" 4 Hole Mount
C10909	Vertical	Single Slot 9" x 11" 3 Hole Mount
G84B100710P1	Horizontal	Single Slot 9" x 11" 3 Hole Mount
PP17672	8 Slot	8 Slot 4 hole 12 1/2" x 19 3/4"
PP12208	Single Slot	8" x 11 1/2"
G84B109851	Single Slot	9" x 11"
G84B102294	3 Slot	10 1/2" x 12 1/2" 4 hole

*Many others available on request.





*“Uniting Innovation, Engineering,
Manufacturing and Distribution”*



PowerRail Bio-Degradable Chemical Line



PowerRail Distribution Inc. is dedicated to provide alternate solutions to the Rail Road industry at competitive pricing.



The newest addition to our family is “Seacole C&H Chemical Line” which offers a Full Line of Locomotive “SOLVENT FREE” Eco-Friendly Engine Products, Degreasers and Cleaners.

We are proactive in providing chemistries that eliminate hazardous waste and the subsequent environmental effect.

299 - WATER LEAK



Concentrated vivid tracing dye for use in detecting water leaks in water cooled engines. Provides a vivid visual marker to trace and see the location of water leaks in normal lighting. Visibility is enhanced using a black light.

<u>PowerRail P/N</u>	<u>Size</u>	<u>Comment</u>
299TRACER-1	16 Oz	Liquid - 12 Per Case

288 FUEL LEAK



Concentrated vivid tracing dye for use in detecting fuel leaks in diesel engines. Provides a vivid visual marker to trace and see the location of water leaks in normal lighting. Visibility is enhanced using a black light.

<u>PowerRail P/N</u>	<u>Size</u>	<u>Comment</u>
288-16-4	16 Oz	Liquid - 4 Per Case
288-2-15	2 Oz	Liquid - 15 Per Case
288-2-96	2 Oz	Liquid - 96 Per Case

810 - HEAT EXCHANGER INHIBITOR

Multi-metal safe corrosion inhibitor packaged in convenient, safety-oriented Sticks for use in locomotive diesel engine cooling systems to protect against premature failure due to corrosion.



<u>PowerRail P/N</u>	<u>Size</u>	<u>Comment</u>
810WATER-BX	15Lb	Stick 15Lb per Box





*“Uniting Innovation, Engineering,
Manufacturing and Distribution”*



PowerRail Bio-Degradable Chemical Line



850 - HEAT EXCHANGER INHIBITOR

Multi-metal safe corrosion inhibitor packaged in convenient, safety-oriented Liquid for use in locomotive diesel engine cooling systems to protect against premature failure due to corrosion.

NO MEASURING - Just Pour Directly Into Radiator



PowerRail P/N	Size	Comment
850COR-5	5 Gallon	Liquid
850COR-55	55 Gallon	Liquid
805COR-275	275 Gallon	Liquid



RADIANCE - HEAT EXCHANGER INHIBITOR WITH TRACER

A concentrated, multi-metal corrosion inhibitor for use in locomotive cooling water systems to protect metals from premature failure due to corrosion and prevent scaling. Contains a concentrated vivid tracer dye for use in detecting water leaks in water-cooled locomotive engines.

Inhibits corrosion of all metals including cast iron, steel, copper, brass, and solder.

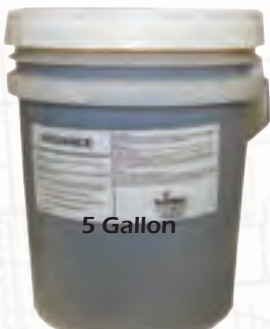

PowerRail P/N	Size	Comment
Radiance-5	5 Gallon	Liquid
RADIANCE-55	55 Gallon	Liquid



POWERRAIL

CREATIVE INNOVATIONS ... CONTINUING TRADITION



PowerRail Bio-Degradable Chemical Line

Rush Inhibitors



PowerRail P/N	Size	Comment
571RUST-5	5 Gallon	Liquid
571RUST-55	55 Gallon	Liquid
573RUST-5	5 Gallon	Liquid
573RUST-55	55 Gallon	Liquid
577RUST-5	5 Gallon	Liquid
577RUST-55	55 Gallon	Liquid



571

Highly concentrated liquid inorganic rust inhibitor engineered for all iron, steel, yellow and soft metal parts when additional corrosion, oxidation or rust protection is needed.

Specifically designed to provide in-process rust protection of parts and for short-term part storage.

Provides superior rust protection in wash and final rinse sections of all aqueous industrial parts washers from heated high-pressure spray cabinet & conveyORIZED systems to free standing manual and immersion type tanks.

Compatible with most alkaline cleaning compounds when simultaneously used.

Harmless to engines and equipment.

577

A highly concentrated liquid inorganic rust inhibitor engineered for indoor storage for all iron and steel metal parts when additional corrosion, oxidation or rust protection is needed.

Specifically designed to provide in-process rust protection of parts and for short-term part storage.

Provides superior rust protection in wash and final rinse sections of all aqueous industrial parts washers from heated high-pressure spray cabinet & conveyORIZED systems to free standing manual and immersion type tanks.

Compatible with most alkaline compounds when simultaneously used.

Harmless to engines and equipment.

573

A pigmented solvent based rust proofing compound designed for long-term outdoor storage of metal parts.

Easily applied and removed and provides a transparent film with up to a year of outdoor rust protection.

Dries quickly to a semi-transparent blue coating/film allowing for easy reading of identification marks.

Easily applied by brush, dip, or spray.



*“Uniting Innovation, Engineering,
Manufacturing and Distribution”*



PowerRail Bio-Degradable Chemical Line

Locomotive Exterior Wash



	Size	Comment
BREAK-32	32 Oz	Spray Bottle
BREAK-5	5 Gallon	Liquid
TOTAL-1	1 Gallon	Liquid
TOTAL-5	5 Gallon	Liquid
TOTAL-55	55 Gallon	Liquid
TOTALB-1	1 Gallon	Liquid
TOTALB-5	5 Gallon	Liquid
TOTALB-55	55 Gallon	Liquid



BREAK

Ready-to-use, multipurpose, heavy-duty liquid detergent for cleaning all hard surfaces.

Specifically formulated to clean oily residues and sooty grime found in factories, bathrooms, vehicles and offices.

Virtually safe on all hard surfaces including: machinery, painted surfaces, wallpaper, counters, desks, and industrial fixtures.

Contains no phosphates, is non-flammable, and is biodegradable and environmentally friendly.

TOTAL

A heavy duty, aluminum safe, high pH, multipurpose degreaser and detergent capable of cleaning and degreasing everything from hard-surface concrete shop floors & walls, to industrial equipment, to company vehicles.

Safe to use anywhere water is tolerable!!!



TOTAL B

A super duty, aluminum safe, high pH, alkaline degreaser and detergent engineered to attack the toughest grease, grime, soil or any other unwanted contaminants associated with facility maintenance cleaning.

Seacole C&H's most powerful multipurpose degreaser and cleaner that is aluminum safe and biodegradable.

Safe to use anywhere water is tolerable!



POWERRAIL

CREATIVE INNOVATIONS ... CONTINUING TRADITION



*“Uniting Innovation, Engineering,
Manufacturing and Distribution”*



PowerRail Bio-Degradable Chemical Line

Parts Washer - Aluminum Safe



PowerRail P/N	Size	Comment
DET14EX-50	50 Lb	Pail
DET14EX-450	450 Lb	Pail
14EXCAL-50	50 Lb	Pail
14EXCAL-450	450 Lb	Pail
SPRAYDETEL-5	5 Gallon	Liquid
SPRAYDETEL-55	55 Gallon	Liquid

SPRAYDET 14EX DRUM



SPRAYDET 14EX

Aluminum safe, inhibited alkaline powdered detergent containing NO useless fillers or additives engineered to produce superior cleaning results for the removal of the toughest contaminants on all metal & plastic surfaces.

BIODEGRADABLE

Performs in all aqueous industrial parts washers including heated high-pressure spray cabinets, conveyor style spray wash systems, freestanding manual and immersion type tanks, and more!

14EX CALIBUR

Aluminum safe, inhibited alkaline powdered detergent containing a proprietary blend of surfactants specifically engineered to produce superior carbon removal and cleaning results on all metal & plastic surfaces.

BIODEGRADABLE

Performs in all aqueous industrial parts washers including heated high-pressure spray cabinets, conveyor style spray wash systems, freestanding manual and immersion type tanks, and more!

SPRAYDET EL

A highly concentrated, aluminum safe, liquid detergent engineered to produce superior cleaning results for the removal of the toughest contaminants on all metal & plastic surfaces.

BIODEGRADABLE

Performs in all aqueous industrial parts washers including: heated high-pressure spray cabinets, conveyor style spray wash systems, free Standing manual and immersion type tanks, and more!



5 Gallon



55 Gallon



POWERRAIL

CREATIVE INNOVATIONS ... CONTINUING TRADITION



*“Uniting Innovation, Engineering,
Manufacturing and Distribution”*



PowerRail Bio-Degradable Chemical Line

Parts Washer - Steel Safe



PowerRail P/N	Size	Comment
ACTION-1	1 Gallon	Liquid
ACTION-5	5 Gallon	Liquid
ACTION-55	55 Gallon	Liquid
AQUASOLVE-1	1 Gallon	Liquid
AQUASOLVE-5	5 Gallon	Liquid
AQUASOLVE-55	55 Gallon	Liquid
SPRAYDETRS-50	50 Lb	Pail
SPRAYDETRS-50	450 Lb	Pail



ACTION CLEANER

Premium quality, heavy-duty, biodegradable liquid detergent with butyl for industrial use in cleaning all hard surfaces.

Extremely powerful in cutting grease and oil eliminating the need to scrub or brush and highly effective in both hot and cold water.

AQUA SOLV II

Aluminum safe, pH neutral, liquid detergent engineered to be specifically used in manual type fountain style aqueous parts washers or “Sink on a Drum” type units to produce superior cleaning results for the removal of the toughest contaminates.

Environmentally green by eliminating the need for harsh cleaning solvents. Biodegradable & environmentally safe.

Contains specialty surfactants for excellent carbon, grease, and grime removal. Non-VOC by CARB definition per ASTM D1298.

SPRAYDETRS

A highly alkaline powdered detergent engineered to produce superior cleaning results for the removal of the toughest contaminates on all FERROUS metal surfaces.

A powerful rust stripper that provides a one-step cleaning process that eliminates acid pickling, neutralizing, and rinsing steps.



Before & After Pics





*"Uniting Innovation, Engineering,
Manufacturing and Distribution"*



PowerRail Bio-Degradable Chemical Line



DEFOAMER O

A highly concentrated, non-silicone, liquid foam suppressant that is compatible when used with all SPRAYDET detergents when additional foam control is necessary.

Specifically designed to quickly eliminate foaming caused by certain equipment types & designs, water quality, types of soils being cleaned and heavy soil loading.

Provides superior foam control in wash and rinse sections of all aqueous industrial parts washers from heated high-pressure spray cabinet & conveyORIZED systems to free standing manual and immersion type tanks.

PowerRail P/N	Size	Comment
DEFOAMER-5	5 Gallon	Liquid



DIRT BUSTER KIT

A heavy duty, aluminum safe, high pH, alkaline multipurpose degreaser and detergent capable of cleaning and degreasing everything from hard-surface concrete shop floors & walls, to industrial equipment, to company vehicles.

Packaged as an EZ Kit for greater economy. Contents include 2 - 2.5-gallon jugs that when mixed together produce 30 gallons of super concentrate.

PowerRail P/N	Size	Comment
DIRTBUSTER-25	2.5 Gallon	Package



EZ SPREAD ICE MELT

A fast, efficient, calcium chloride based ice melt packaged in a safety-oriented lightweight EZ spread 10 pound bag capable of being dispensed using one arm only.

Highly effective at or above temperatures of -25°F!

Economic formulation requires less volume when compared to conventional salt-based ice melts and leaves no white stains or residue.

Railroad Approved for Weight Safety Practice!!!!

PowerRail P/N	Size	Comment
CAL-10	10 Lb	Bag
CAL-10SKID	10Lb	Qty 160 Bags per Skid

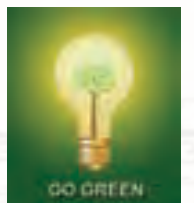



“Uniting Innovation, Engineering,
Manufacturing and Distribution”



PowerRail Bio-Degradable Chemical Line

BioGuard Plus 6™

Biocide and Multifunctional Diesel Fuel Additive

DESCRIPTION, FEATURES & BENEFITS

The only EPA registered fuel microbiocide containing a multifunctional premium diesel additive. Contains **BioGuard™** microbiocide to prevent microbial contamination and fuel filter plugging. Formulated with **Diesel Guard™** to help prevent ultra low sulfur diesel and biodiesel related problems and significantly improve heavy-duty diesel engine performance. Helps reduce fuel consumption, smoke, soot, odor and harmful exhaust emissions.

Contains less than 15ppm of sulfur to comply with ultra low sulfur diesel regulations.

Product performance has been documented in ASTM, SAE and engine manufacturer tests.

Continuous Use Helps To...

- Prevent bacteria and other microbiological growth
- Stabilize fuel to keep it fresh for up to 2 years or more
- Improve thermal stability beyond industry standards
- Control moisture to prevent sludge
- Lubricate fuel injectors & pumps to prevent premature wear
- Prevent fuel filter plugging and extend fuel filter life
- Prevent rust & corrosion
- Increase cetane number
- Dosage 1 Gallon per 1500 Gallons Diesel
- Clean up and prevent fuel injector deposits
- Exceed Cummins L-10 “Superior” injector deposit cleanliness rating
- Reduce piston and combustion chamber deposits
- Increase power and performance*
- Reduce smoke, odor, transom soot *
- Reduce harmful exhaust emissions*
- Contains no alcohol
- Eliminate the need for other fuel additives
- Reduce fuel consumption up to 7.6%*

BGDP632	Qty 12 32 Oz Bottles per case	BGDP625	Qty 2 2.5 Gallon per case
BGDP601	Qty 4 1 Gallon per case	BGDP6-55	55 Gallon Drum

SEASONAL PRODUCTS

688S - PORTABLE TOILET SUMMER

A concentrated liquid odor control agent for use in chemical toilets in airplane, locomotive, RV, bus and portable toilet applications.

A liquid formulation that mixes readily with water, glycol or salt solutions.

No messy powder to handle or clean up.

Contains no hazardous or toxic ingredients.
NO FORMALDEHYDE.



688W - PORTABLE TOILET WINTER

A concentrated liquid odor control agent for use in chemical toilets in airplane, Locomotive, RV, bus and portable toilet applications.

A liquid formulation that mixes readily with water, glycol or salt solutions.

No messy powder to handle or clean up.

Contains no hazardous or toxic ingredients.
NO FORMALDEHYDE.

Provides protection from freezing down to -40°F

PowerRail P/N	Size	Comment
688S-55	55 Gallon	Liquid - SUMMER
688S-55	55 Gallon	Liquid - WINTER



POWERRAIL

CREATIVE INNOVATIONS ... CONTINUING TRADITION



*"Uniting Innovation, Engineering,
Manufacturing and Distribution"*



CENTER PLATES & BOWL LINER

Complete Line of Truck Parts



OEM Ref. #	Type	Description
CBL-120	1 Piece	Style 2 axle rigid truck Assy (3/8"Thk)
CBL-125	1 Piece	Style 2 axle rigid truck Assy (1/2" Thick)
CBL-140	2 Piece	Style Flexicoil truck Assy SD Series
CBL-160	2 Piece	Style 3 axle truck Assy SD-2, SD50/60
CBL-180	2 Piece	Fits GE Style 3 Axle "C" Trucks
CBL-200	2 Piece	Fits GE Style 2 Axle "B" Trucks

CLAMPS

Complete Line of Clamps for Multiple Applications



CONTACTS, ELECTRICAL WIRE & TERMINALS

Complete Line of Electrical Contacts,
Wire and Terminals

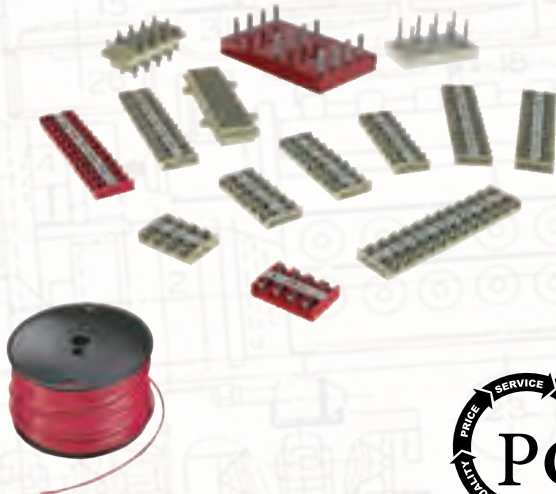

CIRCUIT BREAKERS

Complete Line of Heavy Duty
Circuit Breakers. Below is a
Listing of Common Items



OEM Ref#	Amp	Comment
8458705	2	SINGLE POLE
8456915	5	SINGLE POLE
8458697	10	SINGLE POLE
8458698	15	SINGLE POLE
8458699	30	SINGLE POLE
8458735	3	DOUBLE POLE
8458728	5	DOUBLE POLE
8458736	5	DOUBLE POLE
8458739	15	DOUBLE POLE
8458727	15	DOUBLE POLE
9090434	15	DOUBLE POLE
8458724	30	DOUBLE POLE
8458726	35	DOUBLE POLE
8458738	40	DOUBLE POLE
8414231	50	DOUBLE POLE
8448859	50	DOUBLE POLE
8316879	50	DOUBLE POLE
8433382	60	DOUBLE POLE
8485669	60	DOUBLE POLE
6945270	70	DOUBLE POLE
8433383	100	DOUBLE POLE
8433381	150	DOUBLE POLE
8458741	15	TRIPLE POLE
8458742	30	TRIPLE POLE
41A218545P4	15	SINGLE POLE
41B544907P1	15	SINGLE POLE
41B544907P2	25	DOUBLE POLE
41A212414P14	15	DOUBLE POLE
41A212414P2	30	DOUBLE POLE

We also carry a complete Line
of Electrical Buss Bars and Shunts

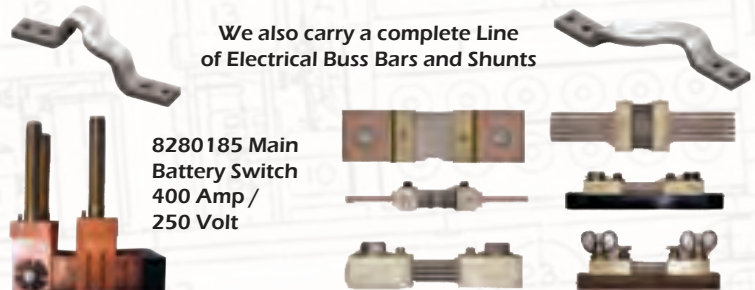

8280185 Main
Battery Switch
400 Amp/
250 Volt



CREATIVE INNOVATIONS ... CONTINUING TRADITION



*“Uniting Innovation, Engineering,
Manufacturing and Distribution”*



COUPLERS - YOKES & DRAFT GEARS

Complete Line of Heavy Duty
AAR Certified Couplers, Yokes and
complete Assemblies New & Unit Exchange



OEM Ref#	Comment
8034983	Coupler Type E Non Alignment
8219072/9329801	Coupler Type E Non Align Control 4888
8349831	Coupler Type F Align Control 8301
8385515	Coupler Type E Align Control 8311/8306
PRD16184269	Mark 50 For 100 Ton Train Cars
499A423P10/8420235	Draft Gear NC-390
6915380/499A180P6	Yoke Only NC 390
8219282/8420236	Draft Gear and Yoke Assembly NC 390
8220283/8252488	Single Draft Gear & Yoke Assy MS-485-6A
8269424	Double Draft Gear & Yoke Assy MS-485-5A
8090508/8236891 8246352	Draft Gear MS-485-5A
343B261P1/6913085 8229465/8253666	Draft Gear MS-485-6A
8236890/8246351	Draft Gear
8420237/499A423P9	Draft Gear NC-391
8420238/41D71673G2	Draft Gear And Yoke Assembly NC 391
8314758	Yoke Only NC 391
8062944	Lock Coupler
8069851	Thrower Coupler
8068119	Lifter Assembly Coupler
8165226/8081918	Coupler Pin 3 15/16 x 13 OAL
9500878	Coupler Pin 3 17/32 Dia. x 12 5/8 In Long
9500877	Coupler Pin 3-17/32 Dia. x 13 In Long
8057698	C10 Knuckle Pin
8055811/8092305	Knuckle Type E50BE
PRD16184064	Block for Non Alignment Coupler

We Offer a Full Line of Parts for the
Complete Coupler Section



New and Unit Exchange Draft Gears



NC-390 Draft Gear



NC-391 Draft Gear



Full Line of Coupling Parts



PRD16184064
Alignment Block for Pocket



E8448086 Pocket





*"Uniting Innovation, Engineering,
Manufacturing and Distribution"*



COMPRESSORS - AIR & WATER

Complete Line of New & Re-Manufactured **"True-Blue™"** series Gardner Denver WBO, WBG and W XO Air Compressors, Parts and Components by ...



Authorized Distributor



Compressor Test Cell



Quality Build Procedures



Remanned Components

New and	Description	Type
W XO	Air Cooled - 3 Cylinder	Low & High Base Single & Double Shaft
W BO	Water Cooled - 3 Cylinder	Low & High Base Single & Double Shaft
W LNA9 Series	Water Cooled - 3 Cylinder	Low & High Base Single & Double Shaft
W LAA9	Water Cooled - 4 Cylinder	Low & High Base Single & Double Shaft
W BG	Water Cooled - 6 Cylinder	Low & High Base Single & Double Shaft



MOTOR DRIVEN AIR COMPRESSOR

Complete Line of Motor Driven Air Compressors utilizing PowerRail **"True-Blue™"** work scopes.
All motors are rewound for Reliability & Durability





*"Uniting Innovation, Engineering,
Manufacturing and Distribution"*



COMPRESSORS - AIR & WATER

Complete Line of New & Re-Manufactured **"True-Blue™"** series Gardner Denver WXO, WBO and WBG Air Compressors, Parts and Components by ...

Common Parts Listing By Air Compressor Model

WXO LP Head	E8042133
WXO LP Cyl.	E8059939
WXO LP Piston	E40017901
WXO LP Rod	E8033545
WXO HP Head	E8033550
WXO HP Cyl	E8083614
WXO HP Piston	E8343422
WXO HP Rod	E8033545
WBO LP Head	E8237532 Both Styles
WBO LP Cyl.	E8237539 Old Style
WBO LP Cyl.	E9518774 New Style
WBO LP Piston	E8338021 Old Style
WBO LP Piston	E40017901 New Style
WBO LP Rod	E8033545
WBO 1/2 Bearing	E8496981
WBO HP Head	E8238541 Old Style
WBO HP Head	E8347435 New Style
WBO HP Cyl	E8237531 Old Style
WBO HP Head	E8347435 New Style
WBO HP Piston	E8343422 Old Style
WBO HP Piston	E40017901 New Style
WBO HP Rod	E8033545

Old Style 8 bolts from underneath
New Style 4 bolts from underneath 4 from top

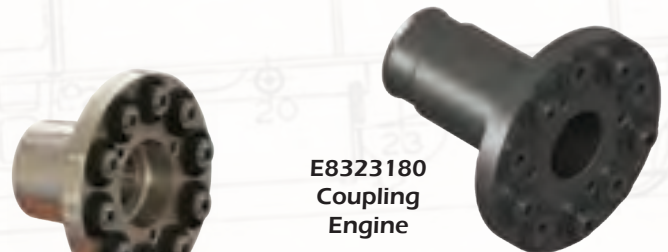

E8236433
Coupling
Air Compressor

E8323180
Coupling
Engine



Valves New and Old Style

- E9319946
- E8424969
- E9319947
- E8424968



E8234958
Bushing

Description

- HP Valve Inlet
- HP Valve Outlet
- LP Valve Inlet
- LP Valve Outlet

TOP DECK KITS

Kits Include all Heads, Liners, Rods, Pistons, Rings, Bearings, Valves, Gaskets & Hardware to do a Complete rebuild in the field. Kits available for WXO, WBO & WBG style compressors Unit Exchange or Outright

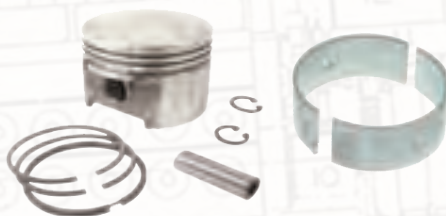



*"Uniting Innovation, Engineering,
Manufacturing and Distribution"*



CONTROL STANDS

PowerRail Electronics Technology Offers a Full Line of **New Control Stands with 100% New Components**



New Stand Ready for Install



PowerRail Electronics Technology also Provides Full Service of Repaired Control Stands and Lockers



***Ask Us About Our New LED Dimmable Bulbs for Control Stands**



Custom Panels Related to PTC Installations



New Anti-Chatter Doors with Adjustable Locks

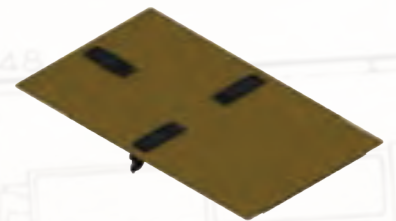

Safety Handles Page 32



100% New & Remanufactured Controllers. Dynamic and Non Dynamic

Controllers New and

- E9093629
- E8226959
- E9325903
- E9091052
- E8227211

Description

- Dynamic Plastic Face
- Dynamic Steel Face
- Dynamic Plastic Face
- NON-Dynamic Plastic Face
- NON-Dynamic Steel Face

Contactors, Controllers, Relays and Modules Page 52

TRAIN SIMULATORS

PowerRail Electronics Technology Offers a Full Line of **New Train Simulators**





*"Uniting Innovation, Engineering,
Manufacturing and Distribution"*



CONTACTORS, CONTROLLERS, RELAYS & MODULES

Complete Line of Control Stands, Controllers, Contactors, Relay, Voltage Regulators and Modules.
Our Line includes **New**, and **"True-Blue™"** Unit Exchange by **PowerRail Electronics & Technology, Savannah Ga.**

Below is a BRIEF Listing of our Quality New & Rebuilt Products

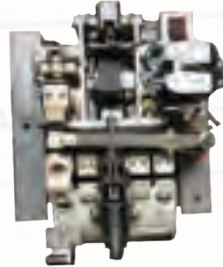
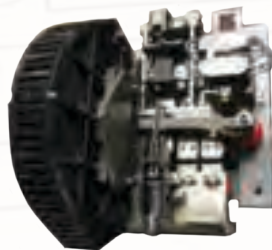

OEM Ref.#

Description

8400143

Contactor Control Cabinet

8251126

Contactor Gen. Shunt Field

8192805

Contactor Power

8458534

Contactor Power

8461331

Contactor Magnetic

8453175

Motor Module Control

8463776

Motor Module Control

9091052

Controller Non Dynamic

9093629

Controller Dynamic & Brake

9325903

Controller Dynamic & Brake

8330790

Voltage Regulator 3 Terminal

8351980

Voltage Regulator 4 Terminal

8484375

6 Panel Light Enhancement

9322456

Rheostat 1500 Ohms

40040084

SGC 5000A Power Contactor

8131665

Reverser 4 motor 4 Contact

8131666

Reverser 2 Motor 2 Contact

17FL & 17FM

GE Aux and Other Modular Panels



POWERRAIL

CREATIVE INNOVATIONS ... CONTINUING TRADITION



*"Uniting Innovation, Engineering,
Manufacturing and Distribution"*



DOOR LOCOMOTIVE FLOORING

Complete Line of PRD Locomotive Cab Flooring
Provides Slip Resistance, Durability and a Permanent
Solution. The Light Weight Aluminum 4' X 8' Panels
are Coated with a
Proprietary Blend
of Minerals and an
Abrasive Epoxy Grit.
Providing Strength,
Durability, and Safety
in Locomotive Cabs

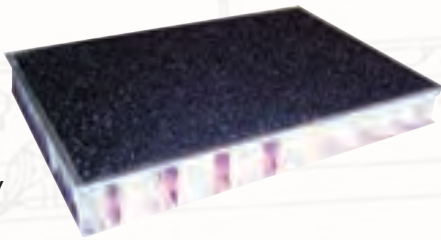

DOOR - BATTERY GRATING

PRD16184575 - 1" Fiberglass Sheet
PRD16184576 - 1 1/2" Fiberglass Sheet

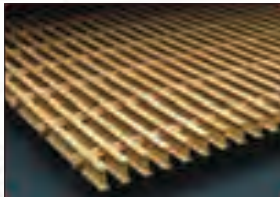

DOOR - WEATHER STRIPPING

Complete Line of Weather-Stripping and Enhanced
Weather-Stripping Seals

PowerRail #	Description
E40014788	SD70 Rear Cab Window and Cab Windshield 15 Ft
E8286959	Weatherstripping Sponge Rubber 5/32 x 1/2 x 50Ft
E8329872	Weatherstripping 7 Ft 4 Inch long
E8419908	Number Board Weatherstripping 80", 1/8" Groove
E9544282	Hinge Guard Weatherstripping 58 7/8"
E6979365	SD60, 70, 80 Cab Door Overlap 74 7/16 x 21 7/16
E8489788	Hood & Sanding Door 10 Ft. Lg 1/8" x 1/4" Groove
E9544282	Hidge Door Guard 58 7/8 Long



DOOR - CAB

Complete Line of Cab Doors, and Windows
PowerDoor is Aluminum that Will Not Rust!!
Complete with Oversized Frame and Lock and
Wiper holes already Pre-Drilled!!!

PowerRail #	Description
E8461881PRD	Alum. Door with Frame Only
E9526353	Glass for Door and Windshield
E8284665	Lock Assembly Keyed
E8465525	Lock Assembly Non Keyed
PRD17164	Slide Lock
E9528757	Window Side 16 x 26 1/4



E8158536
Latch



E8048140
4 x 4 Hinge



E8278056
Slide Lock

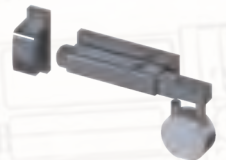

PRD17164
Slide w/ Lock

MODESTY LOCKS

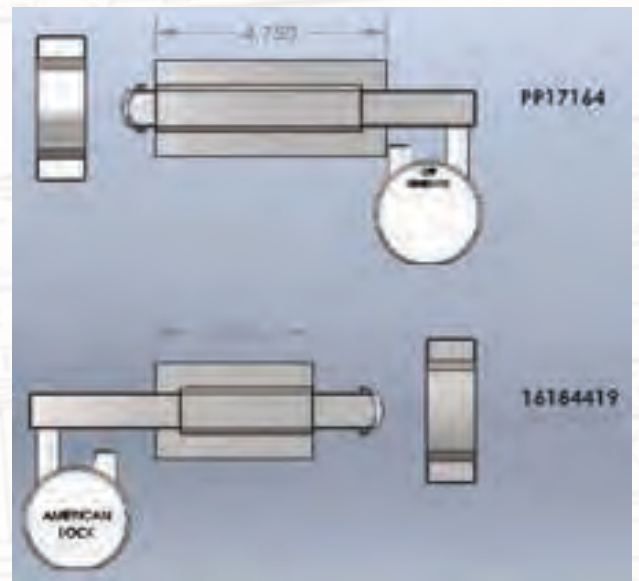

Special Keyed Versions & Other Styles Available





*“Uniting Innovation, Engineering,
Manufacturing and Distribution”*



DOOR LOCOMOTIVE CARBODY

Complete Line of Enhanced **Fiberglass** Doors.

Doors are Fiberglass in lieu of steel. Will Not Rust and reduced weight minimizes injuries related to these products.

60% OR MORE Lighter than Steel Doors!!!



PowerRail #	Description	Length	Application
E9555859	Battery Door	52"	GP/SD Styles - Eng'r & Helper
E9321887	Air Brake Door	63"	GP/SD Styles - Helper Side
E9321884	Air Brake Door	75 1/2"	GP/SD Styles - Eng'r Side
E10584100	Cab Fresh Air	28 3/4"	SD Styles - Helper Side
E10584138	HVAC Door	64 7/8"	SD Styles - Helper Side
E40034382	Battery	48 3/4"	SD Styles - Helper Side
E10576735	Air Brake	64 7/8"	SD Styles - Eng'r Side
E40019273	Air Brake	28 3/4"	SD Styles - Eng'r Side
E40121076	Battery	27"	SD Styles - Eng'r Side
E10666450	Air Brake	29 1/4"	SD Styles - Eng'r Side
E10666451	HVAC w/Vents	29 1/4"	SD Styles - Eng'r Side

ELECTRIC SEMI-CONDUCTOR TESTER

PowerRail DST5000 Tester



- Test SCR's/Thristors
- Test Silicon Diodes
- Test Transistors/IGBT's
- Test Rectifiers
- Test IGTS's

Three Very Important Tests:

- Adjustable from zero to 5000 Volt for testing Forward Blocking. A digital Ammeter indicates leakage current at semiconductor voltage rating.
- Adjustable from zero to 5000 Volt for testing Reverse Blocking. A digital Ammeter indicates leakage current at semiconductor voltage rating.
- Adjustable voltage for Gating or Firing devices. A digital DC Voltmeter indicates actual gate trigger voltage (Vgt). A digital DC Ammeter indicates actual gate current (Igt).

ELECTRICAL - ELECTRONIC

Complete Line of Quality Electrical, Lighting, Resistors, Diodes, Thyristor's and other related components



PowerRail #	Description
E40048214	Insulating Diode Boot
E40029131	AR10 Diode Negative
E40029132	AR10 AR11 Diode Positive
E40032602	AR20 Diode Positive
E40032603	AR20 Diode Negative
E40053999	Diode Positive
E40032602	Diode Negative
E8374003	AR10 Transformer
E9561605	AR11 Transformer
E8380922	Resistor AR10 50W 5 OHMS
E8429166	Resistor 400W 3.75 OHMS
E8004092	Walkaway Step Light
E8004613	Engine Room Light Globe Glass
E8332375	Rubber Standard Lamp Base 4 Holes
E8332374	Rubber Standard Lamp Base 2 Holes
E8207382	Engine Room Guard and Shade Assembly
E8047227	Lamp Guard Assembly Cage
E8228323	Number Light Socket Lamp - Yellow Rubber
E8332375	Socket Lamp, 4 Holes, Rubber, Standard Base





*"Uniting Innovation, Engineering,
Manufacturing and Distribution"*



ENGINES

Complete Line of **"TRUE BLUE™"** Quality Remanufactured Engines by our Partner ...

National

MAINTENANCE & REPAIR, INC.
Hartford, IL (St. Louis)

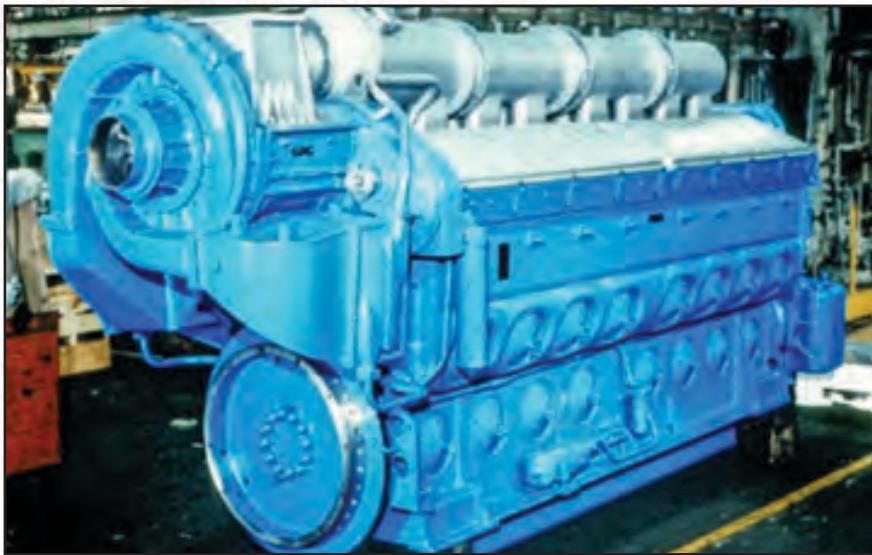

Our Product Line offers a complete line of Remanufactured Engines and Engine Components for the Rail Industry.

We Offer a wide range of 567 - 645 - 710 and 7FDL Type Engines that can support most programs. Services include Unit Exchanged, Remanufactured Outright and Repair/Return.

All Engines are mounted on a Dynamometer to ensure the end user will be able to get a **"TRUE BLUE™"** Turn-Key Engine.

Our shop is **Certified AAR M-1003** and the Quality and Experience of our staff has earned approvals by most Class 1, Class II and Class III and International Railroads.



We also offer FULL Service & Field Support that can also offer rebuilding Engines in the Field including Line Boring

All Engines are Dyno Tested in our Newly Upgrade 5,000 HP EFI Capable Dynamometer to ensure Quality and Reliability



QUALITY & RELIABILITY IS JOB #1



Experience is the key



CREATIVE INNOVATIONS ... CONTINUING TRADITION



*"Uniting Innovation, Engineering,
Manufacturing and Distribution"*



ENGINE POWER ASSEMBLY LINE

Complete Line of **"TRUE BLUE™"** Quality Remanufactured Power Assemblies,
HLP's, Cylinder Heads and other related parts

National

MAINTENANCE & REPAIR, INC.

Hartford, IL (St. Louis)



Quality Workmanship — Quality People



Machining, Re-Qualifying Cylinder Heads



Honing and
Re-Qualifying Liners



Precision Inspection of all Liners



Assembly and testing of all
components





*“Uniting Innovation, Engineering,
Manufacturing and Distribution”*



ENGINE POWER ASSEMBLIES & HLP UNITS

Complete Line of Premium **New** Power Assemblies
AAR Certified Quality

Diamond 9 Head



**CLARK
INDUSTRIAL
POWER**



- Machined & Assembled in USA
- Trademark on **Diamond 9 Head**
- Raw materials meet or exceed current OEM Specifications
- Proven Field Approvals with multiple OEM Builders , Class 1, Regionals, Shortlines & Internationally throughout the world
- Water jackets are thoroughly inspected via bore scope to ensure no debris or casting sand remains.
- Over 39 checkpoints are measured and documented to ensure quality conformance
- State of the art casting techniques reduce porosity and maintain excellent coolant flow
- State of the art casting techniques reduce porosity and maintain excellent coolant flow

Type	New P/A	UX P/A	New HLP	UX HLP
567B	No	Yes	No	Yes
567BC	No	Yes	No	Yes
567C	Yes	Yes	Yes	Yes
567CE	Yes	Yes	Yes	Yes
645E	Yes	Yes	Yes	Yes
645E3	Yes	Yes	Yes	Yes
645E3B	Yes	Yes	Yes	Yes
645E3C	Yes	Yes	Yes	Yes
710	Yes	Yes	Yes	Yes

Please Call Us for Our Line of EPA Tier Packs



Diamond 9 Head Offers
Universal Design 645 & 710
E40021329 Complete with Valves
E40021327 Bare Head Only

Replaces
9556059/9556060/9545727
40021330/40042135/40121467





*“Uniting Innovation, Engineering,
Manufacturing and Distribution”*



ENGINE PARTS OFFERING

Complete Line of New Power Assembly & Related Components
Below is a sampling of our broad range of offerings

OEM Ref #	Description	New	UX
8415993	Liner Cast Iron 645	Yes	Yes
9318833	Liner HUB 645	Yes	Yes
9090233	Liner Chrome 645	Yes	Yes
9546509 - 40014531	Liner HUB 710	Yes	Yes
40060841	Fork Rod	Yes	Yes
9544257	Blade Rod	Yes	Yes
8367800	Carrier 645	Yes	Yes
40006129	Piston Tin Plated HURG Roots	Yes	No
40006130	Piston Tin Plated HURG 645E3	Yes	No
40006131	Piston Tin Plated HURG 645E3B	Yes	No
40033365	Ring Set CI Liner 645	Yes	No
9323296	Ring Set Chrome 645	Yes	No
8269842	Piston Pin 645E	Yes	Yes
40078951	Piston Pin 645E3B	Yes	Yes
8268641	Lower Liner Insert 645	Yes	No
9316139	Lower Liner Insert Hi HP	Yes	No
9583686	Gasket Install Kit Power Assy	Yes	No
9581924	Cyl. Head Seat Ring Viton	Yes	No
121X1306	Rotator Valve Cylinder	Yes	No
140X1063 140X1073	Piston Crown	Yes	No
142X1050	Piston	Yes	No
142X1052	Piston Pin	Yes	No
7FDL	Jackets & Liners		
7FDL	Short Packs and Full	No	Yes





*“Uniting Innovation, Engineering,
Manufacturing and Distribution”*



ENGINE PARTS OFFERING

Complete Line of New Engine Parts & Components
Below is a sampling of our broad range of offerings

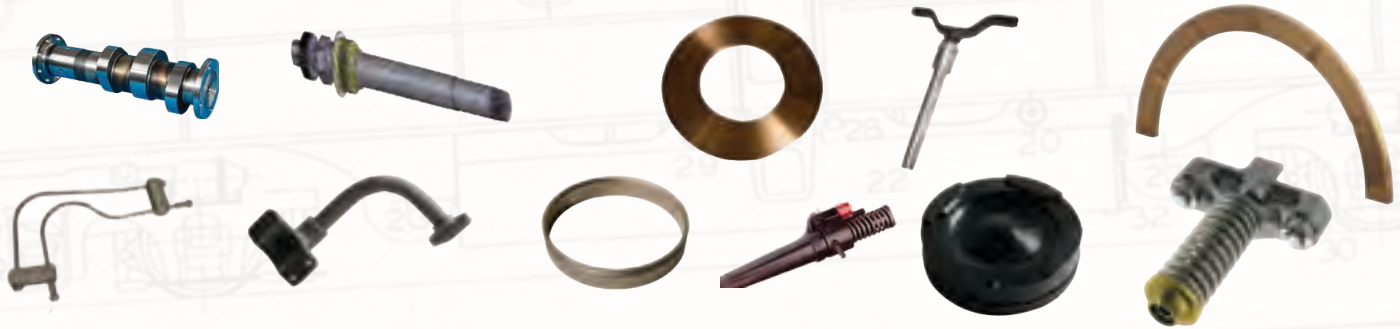

• Camshafts	• Crabs & Bolts	• Cross Heads	• Cylinder Test Valves
• Cylinder Heads	• Engine Protectors	• Fuel Lines	• Fuel Pumps
• Gears	• Hand-Hole Covers	• Liners	• Oil Lines
• Oil Pumps	• “P” Pipes	• Piston & Rings	• Push Rods
• Rods/Carriers	• Water Elbows	• Water Jumpers	• Water Pumps



Common Stock Parts

OEM Ref. #	Description
8028006	Thrust Collar 645
8039842	Lube Oil Line
8048880 - Handle	Cylinder Test Valve 645 T- Handle
8085260	Valve Bridge Assembly
8135330	Trust Washer 645
8160209	Fuel Line
8195996	Flex Coupler
8206804	Water Jumper 567C
8414444	Water Elbow
9093027	Water Jumper 645
9319504	Rocker Arm Assy Injector 645
9319505	Rocker Arm Assy Exhaust 645
9544046	Thrust Collar 710
9546230	Rocker Arm Assy Injector 710

OEM Ref. #	Description
9546232	Rocker Arm Assy Exhaust 710
9549577	P Pipe 567
9549578	P Pipe 645
9581924	Cylinder Head Ring Viton
40036607	Cylinder Test Valve 710
40046561	P Pipe 710
40102453	Trust Washer 710
114X1218	Bonded Drive Couplings
116X1114 / 116X1115	Cam Segment
124X1058 / 124X1068	CrossHeads
140X1826-1 / 140X2950	Fuel Line
150X1232	Linkage
PRD16184502	Oil Sampling Valve 1/4 NPT





*“Uniting Innovation, Engineering,
Manufacturing and Distribution”*



ENGINE PARTS OFFERING

Complete Line of New Engine Parts & Components
Below is a sampling of our broad range of offerings



OEM Ref. #

Description

XXXXX	CrankShafts EMD & GE Style
8261194	Cam Segment 567/645 Non Hardened Engine
8419849	Cam Segment 567/645 Non Hardened Engine
8320994	Block Assembly Camshaft Drilled Flange
8320995	Block Assembly Camshaft Plain Cap
8476507	Main Bearing Cap Center 645
8476508	Main Bearing Cap 12C 645
8476509	Main Bearing Cap Intermediate 645
8476510	Main Bearing Cap Rear
9541514	Main Bearing Cap Intermediate 710
9541512	Main Bearing Cap Center 710
9541511	Main Bearing Cap IRear 710



We stock full Line of Remanufactured
Crankshafts and Cam Shafts





*“Uniting Innovation, Engineering,
Manufacturing and Distribution”*



POWERRAIL MANUFACTURING

Complete Line of New and **“True Blue™”** Remanufactured Engine Components. Roots Blowers, Pumps - Oil, Water & Fuel, Vane Motors, Air Compressors, Starters, Valve Bridges, Rocker Arms, Heat Exchanger including Radiators and Oil Coolers, Wiper Motors & Other Engine Components.



POWERRAIL

CREATIVE INNOVATIONS ... CONTINUING TRADITION



*“Uniting Innovation, Engineering,
Manufacturing and Distribution”*



ENGINE PUMPS - POWERRAIL MANUFACTURING

Complete Line of New and **“True Blue™”** Unit Exchange Water and Oil Pumps
Utilizing Premium Parts and Components



Balancing Impeller

OEM Ref. #	Description	Application
9516925	Water Pump Left Hand SMALL	Roots Blown
9516924	Water Pump Right Hand SMALL	Roots Blown
9503461	Water Pump Left Hand Small	Turbo 16-567/12-645
8296348	Water Pump Right Hand Small	Turbo 16-567/12-645
9503461	Water Pump Left Hand Small	High Capacity
9332825	Water Pump Left Hand Large	Turbo 16-645 - 710
9510677	Water Pump Right Hand Large	Turbo 16-645 - 710
40059826	Water Pump Right Hand	Tier 1
40054890	Water Pump Left Hand	Tier 1
125X1111	Water Pump	Unit Exchange



Precise Positioning

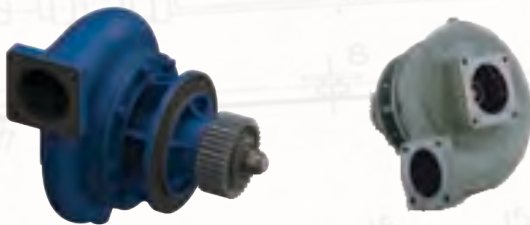

8176033	Piston Cooling Pump	8-567/8-645E
8122947	Lube Oil / Piston Pressure	12-567 / 8-645E
8122949	Lube Oil / Piston Pressure	16-567 & 16-645 Roots 12-645 Turbo
8296366	Lube Oil / Piston Pressure	16-567 / 16-645 / 12-710
40055149	Scavenging Oil Pump	16-710G



Torquing per MI



POWERRAIL
CREATIVE INNOVATIONS ... CONTINUING TRADITION



*“Uniting Innovation, Engineering,
Manufacturing and Distribution”*



ENGINE PUMPS - POWERRAIL MANUFACTURING

Complete Line of New and **“True Blue™”** Unit Exchange Fuel Pumps
Utilizing Premium Parts and Components



ENHANCEMENT

All Remanufacture Pump Motors will offer
NEW Armatures, Bearings and Brushes for Reliability

5540387	1/4HP DC Fuel Pump Motor	with New Armature
4947308	3/4HP DC Fuel Pump Motor	with New Armature
8296428	1/4HP DC Fuel Pump & Motor	with New Armature
40042770	3/4HP DC Fuel Pump & Motor	with New Armature
8498154	Soak Back Pump 1.7GPM	Threaded Connection
8152343	Soak Back Pump 1.7GPM Assy with Motor	Threaded Connection
8498155	Soak Back Pump 1.7GPM	Flanged Connection
8411403	Soak Back Pump 1.7GPM with Motor	Flanged Connection
8498156	Soak Back Pump 3 GPM	Flanged Connection
8492180	Soak Back Pump 3GPM Assy with Motor	Flanged Connection
40009239	Soak Back Assembly 3/4 HP 3GPM	Flanged Connection
8080284	Fuel Pump 4GPM	1/2NPT Threaded Connection
8422951	Fuel Pump 6GPM	Flanged Connection
8425609	Fuel Pump & Motor 3/4HP 6 GPM	Flanged Connection
40042770	Fuel Pump & Motor 3/4HP 6 GPM	Flanged Connection
40122943	AC 4GPM Transfer Pump	
40095692	AC 4GPM Transfer Pump	
132X1750	AC Transfer Pump	
123X1645	Fuel Pump	Unit Exchange
132X1535	Fuel Pump	UX - Bendix Type
149X1014	Fuel Pump	Unit Exchange



Coming Soon!!!

Please call for our new DC Brushless
Motor Line Coming Soon!



CREATIVE INNOVATIONS ... CONTINUING TRADITION



*"Uniting Innovation, Engineering,
Manufacturing and Distribution"*



ENGINE PROTECTORS

Complete Line of New and Re- Manufactured
"True Blue™" Engine Protectors

PowerRail #	Description
E9332828UX	Turbo Delta P
E8446372UX	Turbo Type P
E8474255UX	Roots Type P
E9506013UX	Roots Delta P
E8362040UX	Crankcase Monitor
E8370362UX	Crankcase Monitor



PowerRail #	Description
E9535870	Turbo Delta P Rebuild Kits
E9535868	Turbo Type P Rebuild Kits
E8467306	Roots Type P Rebuild Kits
E9535869	Roots Delta P Rebuild Kits

We also carry Hoses Gaskets and other related parts.

***Parts Are Seal Rebuild Kits**

ENGINE GEARS

Complete Line of New Engine Gears

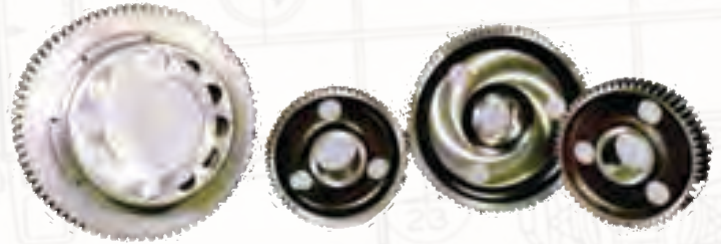

Engine Gears

Drive Gear 58T	8483944
Drive Gear 58T	8543203
Drive Gear 58T	8483945
Drive Gear 79T	8069019
Drive Gear 79T	8360843
Drive Gear 79T	8069014
122 Acc. Drive Gear	8360839 / 8141909
Starter Ring Gear 265T	8416930



PowerRail #	Description
E40051536	Starter Ring 265T
E8416930-PRD3PC	Starter Ring 265T 3 Piece





**“Uniting Innovation, Engineering,
Manufacturing and Distribution”**



ENGINE - GASKET, SEALS AND RUBBER PRODUCTS

Complete Line of New Generation Gaskets, Seals and O-Rings

We are pleased to introduce our NEW C-Swell™ YellowSeal™

Additionally, our rubber products have been enhanced to our NEW VPS Viton® Power Seal material

Marman Seals



***VPS Power Seals *Extended Life *Resistance to Oil & Fuels**

WILL NOT LEAK!

PowerRail P/N

Description

- E8479542 Marman 1/2 Inch
- E8479543 Marman 3/4 Inch
- E8479544 Marman 1 Inch
- E8479598 Marman 1 1/4 In
- E8479599 Marman 1 1/2 In
- E8479600 Marman 2 Inch
- E8479601 Marman 2 1/2 In
- E8479602 Marman 3 Inch
- E8479603 Marman 3 1/2 In
- E8479604 Marman 4 Inch
- E8406231 Marman 6 Inch



PowerRail offers a full line of Marman Couplings and upgraded VPS Viton Power (High Temperature) Seals.

Pipe is measured by its I.D. because a marman seal sits on the outside of the pipe, the I.D. of the seal will be larger than the pipe size.

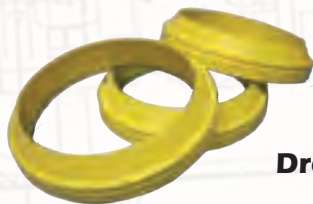

Dresser Seals

PowerRail P/N

Description

- G499A912AEP2 Dresser 1/2 Inch
- G499A912AEP3 Dresser 3/4 Inch
- G499A912AEP4 Dresser 1 Inch
- G499A912AEP5 Dresser 1 1/4 In
- G499A912AEP6 Dresser 1 1/2 In
- G499A912AEP7 Dresser 2 Inch
- G499A912AEP8 Dresser 2 1/2 In
- G499A912AEP9 Dresser 3 Inch
- G499A912AEP10 Dresser 3 1/2 In
- G499A912AEP11 Dresser 4 Inch
- G499A912AEP13 Dresser 6 Inch

COUPLING ASSEMBLY

COMPONENT REFERENCE

Pipe Size (in inches)	Pipe Size (in length)	Complete Assembly (OEM Part No.)	Seal (OEM Part No.)
0.5	4.50	8476711	8479519
0.5	4.50	9559888	8479519
0.75	2.50	8479674	8479520
0.75	4.50	8470605	8479520
1.00	2.875	8470340	8479521
1.00	6.00	8476174	8479521
1.00	7.50	8472849	8479521
2.00	4.00	8474757	8479524
2.00	7.50	8479676	8479524
2.50	4.00	8392458	8479525
2.50	6.50	8472617	8479525
2.50	12.50	8472616	8479525
2.50	23.00	8275374	8479525
2.50	26.00	8284779	8479525
2.50	4.00	9516671	8479525
3.00	6.50	8471160	8479526
3.00	12.50	8468179	8479526
3.00	90°	8455470	8479526
4.00	7.50	8252895	8479528
4.00	6.50	8474741	8479528
4.00	12.50	8470341	8479528
4.00	6.50	8347788	8479528
5.00	6.50	9559099	8479528



POWERRAIL

CREATIVE INNOVATIONS ... CONTINUING TRADITION



*“Uniting Innovation, Engineering,
Manufacturing and Distribution”*



EXHAUST PRODUCTS

Complete Line of Exhaust Chambers, Expansion Joints and Full Systems.
Manufactured by **Avoca Rail Products** Division



567 Chambers - 645 Chambers - 710 Chambers



- | | | |
|---------|-------------------------|------------------------------|
| xxxxxxx | Chamber Assembly 12-645 | Exhaust - Front |
| xxxxxxx | Chamber Assembly 12-645 | Exhaust - Intermediate Front |
| xxxxxxx | Chamber Assembly 12-645 | Exhaust - Intermediate Rear |
| xxxxxxx | Chamber Assembly 12-645 | Exhaust - Rear |
| 9316231 | Chamber Assembly 16-645 | Exhaust - Front |
| 9316232 | Chamber Assembly 16-645 | Exhaust - Intermediate Front |
| 9316233 | Chamber Assembly 16-645 | Exhaust - Intermediate Rear |
| 9316234 | Chamber Assembly 16-645 | Exhaust - Rear |

***Call for 567 & 710 Chamber**



- | | | |
|-------------|------------------------------|--------------------------|
| E8408987 | Expansion Joint | 10 Inch |
| E8408985 | Expansion Joint | 14 Inch |
| E40026936 | High Heat ThermaSeal Gasket | 10 Inch |
| E40026937 | High Heat ThermaSeal Gasket | 14 Inch |
| E40055466 | High Heat ThermaSeal Gasket | Exhaust Stack |
| E40026939 | High Heat Therma Seal Gasket | Expansion Joint to Turbo |
| E8287287 | Bolt | Exhaust Stack |
| E8287287B14 | Bolt High Heat - 710 Engine | Exhaust Stack |
| E9338626 | Nut | Exhaust Stack |
| E9557143 | Turbo Screen | 645 |
| E40155024 | Turbo Screen | 710 |





*“Uniting Innovation, Engineering,
Manufacturing and Distribution”*



EXHAUST PRODUCTS

Complete Line of Exhaust Chambers, Expansion Joints and Full Systems

128x1353-4	Manifold Section	for Single Pipe Manifolds
128x1404	Clamp	for Single Pipe Manifolds
128x1413	Gasket At Turbo Transition	for Dual Pipe Manifolds
128x1444-7	Transition Section	for Single Pipe Manifolds
128x1495	Complete Manifold	8 Cylinder - SS Version
128x1496	Manifold Section - Leg 1R & 4R	8 Cylinder - SS Version
128x1497	Manifold Section - Leg 1L & 4L	8 Cylinder - SS Version
128x1498	Manifold Section - Leg 2R & 3R	8 Cylinder - SS Version
128x1499	Manifold Section - Leg 2L & 3L	8 Cylinder - SS Version
128x1629	End Cover	for Dual Pipe Manifolds
128x1635	Main "T" Section	for Dual Pipe Manifolds
128x1636	Bellows Connector	for Dual Pipe Manifolds
128x1637	Gasket At Sections	for Dual Pipe Manifolds
128x1638	Transition Section	for Dual Pipe Manifolds
128x1639-1	V-Band Clamp	for Dual Pipe Manifolds
128x1640-2	Complete Manifold	16 Cylinder Dual Pipe
128x1642-2	Complete Manifold	12 Cylinder Dual Pipe
128x1648-1	Transition Section	for Dual Pipe Manifolds
128x1657	Manifold Section - Leg 1R & 4R	8 Cylinder - SS Version
128x1658	Complete Manifold	8 Cylinder - SS Version
128x1659	Manifold Section - Leg 1L & 4L	8 Cylinder - SS Version
128x1660	Manifold Section - Leg 2R & 3R	8 Cylinder - SS Version
128x1661	Manifold Section - Leg 2L & 3L	8 Cylinder - SS Version
128x1670	Complete Manifold	12 Cylinder Dual Pipe
128x1730	End Section	





*"Uniting Innovation, Engineering,
Manufacturing and Distribution"*



FASTENERS

Complete Line of Fasteners, Including Nuts, Bolts, Washers, Screws, and Much More

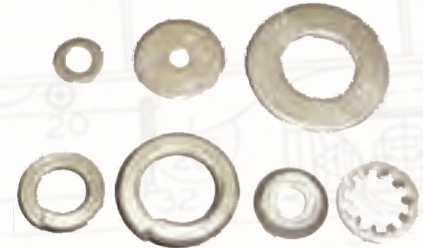

General Fasteners

<u>OEM Ref. #</u>	<u>Description</u>
12538-0008	Fastener Kit (For 8004092 Step Light)
40055467	5/8-18 x 4 1/4 Chamber To Crankcase
8029567	1 1/4-12 x 2 3/4 Flange Retaining Bolt
8034693	3/8-24 X 2 1/2 - 7/16 Camshaft Bolt
8127868	5/8-18 x 1 3/4 Upper Forkrod Basket
8159340	Bolt Assembly Piston Pin to Connecting Rod
8242193	1 3/8-6 x 3 Axle Cap Bolt
8261288	3/4-16 x 11 5/16 Bolt
8266137	1 1/4-12 x 7 Special Bolt
8322027	1-8 x 7 1/2 4140 Gear Case Safety Strap T-Bolt
8460207	5/8-18 x 3 1/4 Assembly Exhaust Chamber Bolt
9085894	1 3/4-12 X 15 5/8 Crab Bolt
9338626	1/2-20 Exhaust Manifold Nut
N170P25024	3/8-16 x 1 1/2 Coupling To Hub Bolt
41A222526P1	1/2-13 x 2 1/4 Support To Turbo Bolt
41A232240P1	1 1/2-6 x 5 Gear Case W/Hole In Center
41B514152G2	1/2-13 x 3 13/16 12 Bolt Crown
41B520026P2	1 1/4-12 x 8 11/16 Cylinder Hold Down Bolt
84B522252P1	Banjo Bolt

Specialty Locomotive Engine Bolts

<u>OEM Ref. #</u>	<u>Description</u>
8300183	2 3/4-8 Nut Pinion Retaining D77
8127868	5/8-18 x 1 3/4 Bolt W/Washer
8259128	1/2-20 X 2 3/4 Bolt Lower Basket Assembly
8260114	17/32 ID X 1 Washer Connecting Rod
8460207	5/8-18 x 3 1/4 Bolt Assembly Chamber Exhaust
8487883	1/2-20 Locknut Lower Basket Assembly
733P29024	1/2-13 x 1-1/2 12 Point Flange Bolt
N22P39080	1-8 x 5 Hex Flange Head Bolt
N56P16014	10-32 x 7/8 Pan Head Screw
N733P33020	5/8-11 x 1 1/4 12 Point Flange Bolt
41A221837P5	Washer Sealing
41A221875P1	5/8-11 x 1 3/4 Bolt
41A222526P1	1/2-13 x 2 1/4 Bolt Support To Turbo
41A231439P15	5/16-18 x 5/8 Bolt Assembly
41A235717P8	3/8-16 x 1 1/4 Indented Bolt
41B513140P2	Stud Nozzle Hold Down
41B513360G2	Screw w/ Button Tappet
41B514152G2	1/2-13 x 3 13/16 12 Bolt Crown To Skirt

Many More Fasteners Available - Call For More Details





*“Uniting Innovation, Engineering,
Manufacturing and Distribution”*



ENGINE - FILTER

Complete Line of New Air, Fuel & Oil Filters

We can provide filters in broken case lots or save on Inventory Cost by purchasing kits

Air Filters

OEM Ref.#	Application	
AA-1	41C625459P1	12 x 8 Auxiliary Cabinet Cylindrical Element
AB-10	8363343	7 3/4 x 5 3/8 Salem #824 Coalescer Element
AE-1	41A216508P4	16 x 9 Engine Intake Cylindrical Element
AE-15	9316812	22 x 14 x 6 Pleated Paper Tri-cell Engine Intake Element
AE-25	9093588	36 x 14 x 6 Pleated Paper Tri-cell Engine Intake Element
AE-30	9093587	45 x 14 x 6 Pleated Paper Tri-cell Engine Intake Element
AE-520T	9331452	20 x 20 x 5 Pleated Paper Tri-cell Engine Intake Element
AE-529	9331454	29 x 20 x 5 Pleated Paper Tri-cell Engine Intake Element
AK-2	8402068	12 x 8 Cylindrical Air Compressor Intake
AK-3	8347199	19 1/2 x 5 7/8 x 8 Pamic-style Air Compressor Intake
DP240-0922	8310098	9 x 20 x 2 30/30 Carbody Pleated
DP240-1620	40087224	16 x 20 x 2 30/30 Carbody Pleated
DP240-1625	8367085	16 x 25 x 2 30/30 Carbody Pleated
DP240-2020	40083927	20 x 20 x 2 30/30 Carbody Pleated
DP240-2025	N/A	20 x 25 x 2 30/30 Carbody Pleated
EG-1	8470903	29 x 27 x 6 Standard Filter Baggie
EGP-1	40086945	29 x 27 x 6 Standard Filter Baggie - LONG LIFE 180 Day
EG-2	9522063	19 x 22 x 5 Small Filter Baggie
EGP-2	84C622136P1	19 x 22 x 5 Small Filter Baggie - LONG LIFE 180 Day
FP0922	8310098	9 x 22 x 3 3/4 Fiberglass Carbody Pad
FP0922MOD	8310098MOD	9 x 22 x 3 3/4 Paper Long Life Carbody Pad
FP1625	8380459/40083928	16 x 25 x 3 3/4 Fiberglass Carbody Pad
FP1625MOD	8380459/40083928MOD	16 x 25 x 3 3/4 Paper Long Life Carbody Pad
FP2020	8280211	20 x 20 x 3 3/4 Fiberglass Carbody Pad
FP2020MOD	8280211MOD	20 x 20 x 3 3/4 Paper Long Life Carbody Pad
HH-1734	22109618	17 x 34 x 2 HVAC Condenser Coil
ICE-1010	40041374	9 1/2 x 10 3/4 x 1 1/2 Cabin Electronics
PA2580	9093553	12 3/4 x 23 1/2 Engine Air Intake Cylindrical Element

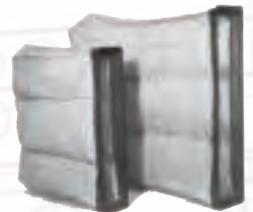
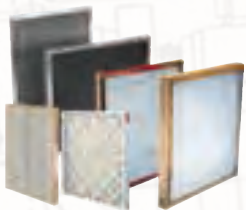

POWERRAIL

CREATIVE INNOVATIONS ... CONTINUING TRADITION



Fuel Filters



OEM Ref. #		Application
C-132XF-2	132X1250-2	6 1/2 x 30 Fuel Element Standard-life
CMAX-12	EMD type	6 1/2 x 30 Max. Capacity
CMAX-184H	EMD type	6 1/2 x 30 Ultra-Max. Capacity
CMAX-24	EMD type	6 1/2 x 30 Max. Capacity
FF-1B	8299457	2 1/2 x 7 3/4 Roll-Pak Sock Element
FH-1B	8302891	3.38 x 9.75 Fuel Filter with Spring
FJ-2S	8423132	3 3/4 x 7 Fuel Spin-on
FJ-33S	40052587	3 5/8 x 8 1/2 Fuel Spin-on
FJ-44S	40053463	5 3/8 x 9 1/2 Fuel Spin-on
FL-2W	41B514746P1	2 3/4 x 8 3/4 Suction Strainer W/spring
FL-3W	40061834	2 3/4 x 8 3/4 Suction Strainer W/spring
HA-1P1S	132X1818	9 7/8 x 30 One Stage Fuel Filter
HA-1P2S	9545152	9 7/8 x 30 Two Stage Fuel Filter
HA-2P1SF	40074677	9 7/8 x 30 2-piece One Stage Fuel Filter
HA-2P2SF	40056007	9 7/8 x 30 2-piece Two Stage Fuel Filter
HAF-2P2SF	84D721178P2	9 7/8 x 30 2-piece Two Stage Fuel Filter
HAF-3P2S-45	40106208	9 7/8 x 45 3-piece Two Stage Fuel Filter
HE-2P1SF	EMD/GE type	9 7/8 x 30 2-piece One Stage Fuel Filter
HMAX-2P1S	EMD/GE type	9 7/8 x 30 2-piece One Stage Fuel Filter Extended-Life
HMAX-2P2SF	EMD/GE type	9 7/8 x 30 2-piece Two Stage Fuel Filter Extended-Life
S-2	8275432	6 x 30 Roll-Pak Sock Element
S-6	8281232	6 x 28 1/2 Flow-thru with Single Seal Sock Element

OEM Ref. #		Application
BT267	9311037	4 x 6 Air Compressor Spin-on
C-12/C-24	8345482	6 1/2 x 30 Long-life Lube Oil
C-52	2X4223	6 1/2 x 30 Long-life
CMAX-12	EMD type	6 1/2 x 30 Long Life Lube Oil Filter
CMAX-184H	EMD type	6 1/2 x 30 Long Life Lube Oil Filter Ultra Cap.
CMAX-24	EMD type	6 1/2 x 30 Max. Capacity
CMAX-52	GE type	6 1/2 x 30 Max. Capacity
FG-3W	9324489	3 x 5 1/4 Lube Oil Suction Strainer
TL-2C	8322064	4 1/2 x 20 Turbo Standard-life Element
TL-2FSO	40035123	5 1/2 x 12 Turbo Spin-on Long-life
TL-3C	8340000	3 x 7 1/4 Soak Back Spin-On Standard-life
TL-3FSO	40058635	3 x 7 1/4 Soak Back Spin-On Long-life



*“Uniting Innovation, Engineering,
Manufacturing and Distribution”*



PowerRail Flexi-Filter Generic Kits

PowerRail Distribution Inc Offers a True Cost Savings by offering Customs Kits dedicated to the Railroad’s Road Units.

PowerRail Kits will be Custom Assembled and Tagged by the Customers Road Unit Number which makes ease for ordering.

In addition to the Filters we also can add other items such as Light Bulbs, Carbon Brushes, Wiper Blades and Fuses (to mention a few).



Filter Kit PRDX7005

GP40 FILTER CHANGE OUT KIT		
Qty	OEM Ref. #	Application
8	8345482	C-12/C-24 Lube Filter
1	8275432	S-2 Primary Fuel Filter
2	8423132	FJ-2S Secondary Fuel Filter Spin-on
1	8322064	TL-2C Turbo -Paper Cartridge
1	8340000	TL-3C Soak Back
1	* 9330535	AK-2 Air Compressor Intake Filter
1	* 8347199	AK-3 Air Compressor Intake Filter
1	9311037	BT-267 Air Compressor Lube Filter
2	8343161	Gasket Fuel Strainer/Soak Back
1	8358905	Gasket Primary Fuel
1	8268756	Gasket Lube Oil
1	8288955	Gasket Turbo
* Note - May need EG-1 or EG-2 Baggies Intake Filters		

EMD SW 1500 FILTER CHANGE OUT KIT		
Qty	OEM Ref. #	Application
4	8345482	C-12/C-24 Lube Filter
2	8275432	S-2 Primary Fuel Filter
1	* 9330535	AK-2 Air Compressor Intake Filter
1	* 8347199	AK-3 Air Compressor Intake Filter
1	9311037	BT-267 Air Compressor Lube Filter
1	8343161	Gasket Fuel Strainer

GP40 FILTER CHANGE OUT KIT		
Qty	OEM Ref. #	Application
7	8345482	C-12/C-24 Lube Filter
1	8275432	S-2 Primary Fuel Filter
2	8423132	FJ-2S Secondary Fuel Filter Spin-on
1	8322064	TL-2C Turbo -Paper Cartridge
1	8340000	TL-3C Soak Back
1	* 9330535	AK-2 Air Compressor Intake Filter
1	* 8347199	AK-3 Air Compressor Intake Filter
1	9311037	BT-267 Air Compressor lube Filter
2	8343161	Gasket Fuel Strainer/Soak Back
1	8358905	Gasket Primary Fuel
1	8288955	Gasket Turbo

EMD GP38 FILTER CHANGE OUT KIT		
Qty	OEM Ref. #	Application
7	8345482	C-12/C-24 Lube Filter
3	8470903	EG-1 Baggie Intake Filters
1	8275432	S-2 Primary Fuel Filter
2	8423132	FJ-2S Secondary Fuel Filter
1	* 9330535	AK-2 Air Compressor Intake Filter
1	* 8347199	AK-3 Air Compressor Intake Filter
1	9311037	BT-267 Air Compressor Lube Filter
1	9324489	FG-3W Fuel Strainer
1	8358905	Gasket Primary Fuel
1	8343161	Gasket Fuel Strainer

Note: The Above Tables Reflect a Sampling Only.
Let us Customize the Kit for you.





*"Uniting Innovation, Engineering,
Manufacturing and Distribution"*



FILTERS - AIR LINE

Full Line of Filters for
Coalescing and Air Dryers



<u>OEM Ref. #</u>	<u>Alt Part#</u>	<u>Description</u>
10565991	75-018	Repair Kit
8363343	AB-10/160-004	Salem 824 Filter
40086698	125-132	Salem 824 Filter
40015249	5237-30-0	Salem 818 Filter
40028168	5664-013	Filter Element for 975-075
P40696	P40696	Filter Coalescer
P32208	P32208	Filter Final
40054494	P40968	Filter Element
5X1109	PM5015	Main Element Kit for PM548
P31309	PM31309	Aux Filter Kit

FANS ENGINE COOLING & GRID

Full Line of New and Re-Manufactured
"True Blue™" Engine Fans and Electrical Grid Fans



<u>OEM Ref. #</u>	<u>Description</u>
5526299	36" 12HP 10 Blade
8311479	48" 28HP 6 Blade
8310416	48" 35HP 8 Blade
8379212	48" 35HP 9 Blade
9517833	48" 50HP 8 Blade
9576052	48" 50HP 8 Blade 2 Speed
8281907	48" 18HP Resistor Grid Fan
9514316	48" 36HP Resistor Grid Fan
8388333	48" Fan Guard
9096227	Air Cylinder 1 5/8 Stroke
9569860	Air Cylinder 3 1/2 Stroke
9558527	Fan Blade ONLY



FUSES

Complete Line of Electrical Fuses
for demanding Applications

<u>OEM Ref.#</u>	<u>Amp</u>	<u>Application</u>
8004544	150A	Aux. Generator
8004545	100A	Battery Charging
8004546	60A	Alternator Field
8004570	80A	Battery Field
8004548	30A	Generator Field
8060582	400A	Starter Motor
8042739	400A	Fuse Link Starter
8127051	150A	Boiler
8152419	60A	Battery Field
8346478	800A	AR10
8407729	425A	AR12
8414678	800A	Starter Motor
8439559	200A	Cooling Fan
9330514	450A	AR11 Transition
9330515	450A	AR11 Transition
40028900	550A	AR11
40084060	500A	SD70 Air Compressor



Fusee Holder P50026-5



Fusee Holder P50026-16



Fusee Holder P50026-23



POWERRAIL

CREATIVE INNOVATIONS ... CONTINUING TRADITION



*"Uniting Innovation, Engineering,
Manufacturing and Distribution"*



FUSE HOLDERS

Complete Line of Fuse Holders



OEM Ref. #	Description
8280183	31-60 Amp 250 Volt
8029220	60-100 Amp 250 Volt
8280184	0-30 Amp 250 Volts
8280180	61-100 Amp 3/8"-16 x 1 3/4"
8280181	101-200 Amp 1/2"-13 X 2-1/4"
8280182	201-400 Amp 3/4"-16 X 3-1/4"
8280183	31-60 Amp 5/16"-18 x 1 3/4"
8280185	Switch Main Battery Knife Style

**GAGES - AIR FLOW INDICATORS
FUEL AND AMMETERS**

Complete Line of Air Flow Indicators,
Fuel Gauges, & Ammeters



OEM Ref. #	Description
10601196	Air Flow Indicator
40017162	Air Flow Indicator
8195741	Air Flow Indicator
8387634	Air Flow Indicator, 60-160 lbs.
84B104054P1	Air Flow Indicator
10590743	Ammeter Load Indicator SD60
40150894	Ammeter, Control Stand, SD40-E
8214188	Ammeter TM 0-1500 AMPS
8380058	Ammeter Traction Motor 0-1500AMP
8438032	Ammeter Load Gauge 0-1500AMP
8402426	Ammeter Traction Motor Load
9573315	Ammeter Load Indicator
10599378	Complex Gauge Assembly with AFM Indicator 4 1/2"
8315266	Compressor Gauge, Float Type

GAUGES

Complete Line of Dry and Liquid Filled Gauges



OEM Ref. #	Description
40031338	2 1/2" 0-100 PSI Dry Gauge Oil
8340547	2 1/2" 0-200 PSI Dry Gauge Air
40018397	3 1/2" 0-160 PSI Dry Gauge Oil
40018396	3 1/2" 0-200 PSI Dry Gauge Air
8015552	3 1/2" 0-160 PSI Dry Gauge Air
8032122	3 1/2" 0-100 PSI Dry Gauge Fuel Oil
8032123	3 1/2" 0-100 PSI Dry Gauge Oil
8037304	3 1/2" 0-160 PSI Dry Duplex Gauge Air
8047964	3 1/2" 0-200 PSI Dry Duplex Gauge Air
8231593	3 1/2" 0-200 PSI Dry Gauge Oil
8231594	3 1/2" 0-160 PSI Dry Gauge Oil
8380610	3 1/2" 0-200 PSI Dry Duplex Gauge Air
8387352	3 1/2" 0-160 PSI Dry Duplex Gauge Air
41A304641ABP1	4" 0-200 PSI Liquid Gauge Oil
41B536099P3	4" 0-100 PSI Liquid Gauge Fuel
8459294	4 1/2" 0-160 PSI Duplex Dry Gauge Air
8481962	4 1/2" 0-160 PSI Dry Duplex Gauge
8484326	3 - 4 1/2" 0-160 PSI Duplex Dry Gauge
9080722	2 - 4 1/2" 0-160 PSI Dry Duplex Gauge
9329370	4 1/2" 0-160 PSI Dry Duplex Gauge
9540228	4 1/2" 0-160 PSI Duplex Dry Gauge Air





*“Uniting Innovation, Engineering,
Manufacturing and Distribution”*



GEAR CASES

Complete Line of Grease & Oil GearCases



Patent Pending

PowerLok Oil & Grease Filled GearCases PowerLok Combination Oil / Grease Filled GearCases

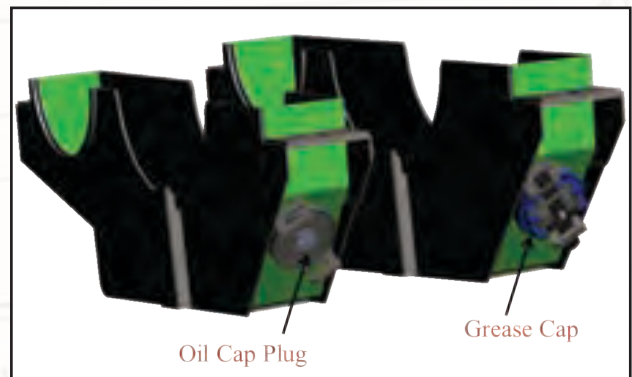
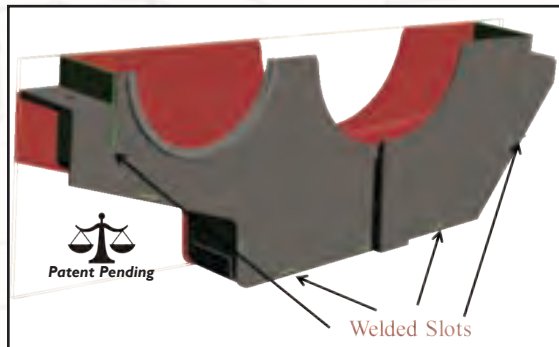

Tab and Slot Design

- 100% Slot Alignment For Better Fit and Operation
- Strengthens the Seams for **Heavy Impact Resistance**
- More Welding Points **Improved Integrity and Strength**
- CNC Robotic Welder Provides Stronger Welds vs. That of Contemporary Welds
- CNC Robotic Welder Provides Less Heat Which Lowers Fatigue Typically Found on Contemporary Welds
- ***Patent Design** - Mechanical and Electro Mechanical

Dual Cap Purpose

- Cap Drilled and Pinned to Prevent Improper Use

Benefits

- Full Line of **PowerLok Oil & Grease GearCases**
- Less Inventory - Offering Both Designs
- **New Combination Oil & Grease GearCases**
AND
Original Design Oil Or Grease GearCases
- Reduction in Hazard Material Spills
- Reduction in Down Time Due to Small Derailments
- Increased Reliability and Service Life
- **Our New CNC Robotic Welder provides stronger welds vs. that of contemporary welds**
- **Our New CNC Robotic Welder provides less heat which lowers fatigue typically found on contemporary welds**

***Enhanced Strength Design
Drastically Reduces Derailment***

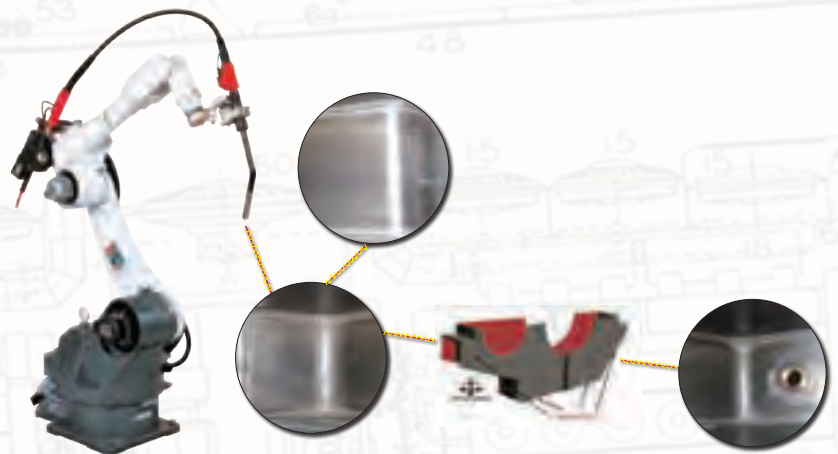

Also Offering **Original Design Grease & Oil GearCases - PLOCK**



Call Our Team for Pricing and Availability!



*“Uniting Innovation, Engineering,
Manufacturing and Distribution”*



EMD GEARCASES

PRD#	REF. #	DESCRIPTION	TM	SEALS	RATIO	LOCOMOTIVES	LUBE
E9540306PLOCK	9540306	LOWER GEARCASE	D77/87	PLASTIC	62:15	DD, F, F7A, F7B, FP, GP, SD, SDP, SW, NR11	GREASE
E9540306COMBO	9540306	LOWER GEARCASE	D77/87	PLASTIC	62:15	DD, F, F7A, F7B, FP, GP, SD, SDP, SW, NR11	GREASE or OIL
E9540307PLOCK	9540307	LOWER GEARCASE	D77/87	PLASTIC	62:15	DD, F, F7A, F7B, FP, GP, SD, SDP, SW, NR11	GREASE
E9540307COMBO	9540307	LOWER GEARCASE	D77/87	PLASTIC	62:15	DD, F, F7A, F7B, FP, GP, SD, SDP, SW, NR11	GREASE or OIL
E9540598PLOCK	9540598	UPPER GEARCASE	D77/87	PLASTIC	62:15	DD, F, F7A, F7B, FP, GP, SD, SDP, SW, NR11	GREASE
E9540598COMBO	9540598	UPPER GEARCASE	D77/87	PLASTIC	62:15	DD, F, F7A, F7B, FP, GP, SD, SDP, SW, NR11	GREASE or OIL
E40021647PLOCK	40021647	LOWER GEARCASE	D77/87	PLASTIC	62:15	DD, F, F7A, F7B, FP, GP, SD, SDP, SW, NR11	OIL
E40021647COMBO	40021647	LOWER GEARCASE	D77/87	PLASTIC	62:15	DD, F, F7A, F7B, FP, GP, SD, SDP, SW, NR11	GREASE or OIL
E40024857PLOCK	40024857	UPPER GEARCASE	D77/87	PLASTIC	62:15	DD, F, F7A, F7B, FP, GP, SD, SDP, SW, NR11	OIL
E40024857COMBO	40024857	UPPER GEARCASE	D77/87	PLASTIC	62:15	DD, F, F7A, F7B, FP, GP, SD, SDP, SW, NR11	GREASE or OIL
E8301948PLOCK	8301948	UPPER GEARCASE	D77/87	FELT	62:15	DD, F, F7A, F7B, FP, GP, SD, SDP, SW, NR11	GREASE
E8301948COMBO	8301948	UPPER GEARCASE	D77/87	FELT	62:15	DD, F, F7A, F7B, FP, GP, SD, SDP, SW, NR11	GREASE or OIL
E9315720PLOCK	9315720	LOWER GEARCASE	D77/87	FELT	62:15	DD, F, F7A, F7B, FP, GP, SD, SDP, SW, NR11	GREASE
E9315720COMBO	9315720	LOWER GEARCASE	D77/87	FELT	62:15	DD, F, F7A, F7B, FP, GP, SD, SDP, SW, NR11	GREASE or OIL
E9310002PLOCK	9310002	LOWER GEARCASE	D77/87	PLASTIC	62:15	DD, F, F7A, F7B, FP, GP, SD, SDP, SW, NR11	GREASE
E9310002COMBO	9310002	LOWER GEARCASE	D77/87	PLASTIC	62:15	DD, F, F7A, F7B, FP, GP, SD, SDP, SW, NR11	GREASE or OIL
E40038097PLOCK	40038097	LOWER GEARCASE	D70	PLASTIC	83:18	SD70, SD751, SD80MAC, SD90AC, SD90MAC	OIL
E40038097COMBO	40038097	LOWER GEARCASE	D70	PLASTIC	83:18	SD70, SD751, SD80MAC, SD90AC, SD90MAC	GREASE or OIL
E4003808PLOCK	40038098	UPPER GEARCASE	D70	PLASTIC	83:18	SD70, SD751, SD80MAC, SD90AC, SD90MAC	OIL
E40038098COMBO	40038098	UPPER GEARCASE	D70	PLASTIC	83:18	SD70, SD751, SD80MAC, SD90AC, SD90MAC	GREASE or OIL
E40046866PLOCK	40046866	LOWER GEARCASE	D90/100	PLASTIC	83:18	SD70, SD751, SD80MAC, SD90AC, SD90MAC	OIL
E40046866COMBO	40046866	LOWER GEARCASE	D90/100	PLASTIC	83:18	SD70, SD751, SD80MAC, SD90AC, SD90MAC	GREASE or OIL
E40046865PLOCK	40046865	UPPER GEARCASE	D90/100	PLASTIC	83:18	SD70, SD751, SD80MAC, SD90AC, SD90MAC	OIL
E40046865COMBO	40046865	UPPER GEARCASE	D90/100	PLASTIC	83:18	SD70, SD751, SD80MAC, SD90AC, SD90MAC	GREASE or OIL
E40017363PLOCK	40017363	UPPER GEARCASE	D87BTR	PLASTIC	70:17	GP60, SD60I	OIL
E40017363COMBO	40017363	UPPER GEARCASE	D87BTR	PLASTIC	70:17	GP60, SD60I	GREASE or OIL
E40017364PLOCK	40017364	LOWER GEARCASE	D87BTR	PLASTIC	70:17	GP60, SD60I	OIL
E40017364COMBO	40017364	LOWER GEARCASE	D87BTR	PLASTIC	70:17	GP60, SD60I	GREASE or OIL
E9540579PLOCK	9540579	UPPER GEARCASE	E MOTOR	PLASTIC	65:12	DD, F, FP, GP, DP, SW	GREASE
E9540579COMBO	9540579	UPPER GEARCASE	E MOTOR	PLASTIC	65:12	DD, F, FP, GP, DP, SW	GREASE or OIL

Also Offering **Original**
Design Grease & Oil
GearCases - PLOCK



Call Our Team for Pricing
and Availability!



*“Uniting Innovation, Engineering,
Manufacturing and Distribution”*



EMD GEARCASES (cont.)

E9541129PLOCK	9541129	LOWER GEARCASE	E MOTOR	PLASTIC	65:12	DD, F, FP, GP, DP, SW	GREASE	
E9541129COMBO	9541129	LOWER GEARCASE	E MOTOR	PLASTIC	65:12	DD, F, FP, GP, DP, SW	GREASE or OIL	
E8301947PLOCK	8301947	UPPER GEARCASE	E MOTOR	FELT	65:12	DD, F, FP, GP, DP, SW	GREASE	
E8301947COMBO	8301947	UPPER GEARCASE	E MOTOR	FELT	65:12	DD, F, FP, GP, DP, SW	GREASE or OIL	
E8302646PLOCK	8302646	LOWER GEARCASE	E MOTOR	FELT	65:12	DD, F, FP, GP, DP, SW	GREASE	
E8302646COMBO	8302646	LOWER GEARCASE	E MOTOR	FELT	65:12	DD, F, FP, GP, DP, SW	GREASE or OIL	
E8429098PLOCK	8429098	UPPER GEARCASE	D29/43	FELT	71:18	REPLACES 8283441	GREASE	
E8429098COMBO	8429098	UPPER GEARCASE	D29/43	FELT	71:18	REPLACES 8283441	GREASE or OIL	
E8283442PLOCK	8283442	LOWER GEARCASE	D29/43	FELT	71:18		GREASE	
E8283442COMBO	8283442	LOWER GEARCASE	D29/43	FELT	71:18		GREASE or OIL	
E9557134PLOCK	9557134	UPPER GEARCASE	D29/D44	PLASTIC	NARROW 71:18		GREASE	
E9557134COMBO	9557134	UPPER GEARCASE	D29/D44	PLASTIC	NARROW 71:18		GREASE or OIL	
E9559650PLOCK	9559650	LOWER GEARCASE	D29/D43	PLASTIC	NARROW 71:18		GREASE	
E9559650COMBO	9559650	LOWER GEARCASE	D29/D43	PLASTIC	NARROW 71:18		GREASE or OIL	
E8344966PLOCK	8344966	UPPER GEARCASE	D29CC	FELT	NARROW	G18, GL22	GREASE	
E8344966COMBO	8344966	UPPER GEARCASE	D29CC	FELT	NARROW		GREASE or OIL	
E8344965PLOCK	8344965	LOWER GEARCASE	D29CC	FELT	NARROW	GT22, G26, GT26	GREASE	
E8344965COMBO	8344965	LOWER GEARCASE	D29CC	FELT	NARROW		GREASE or OIL	
E40105121PLOCK	40105121	UPPER GEARCASE	70ACE	PLASTIC			OIL	
E40105121COMBO	40105121	UPPER GEARCASE	70ACE	PLASTIC			GREASE or OIL	
E4015120PLOCK	4015120	LOWER GEARCASE	70ACE	PLASTIC			OIL	
E4015120COMBO	4015120	LOWER GEARCASE	70ACE	PLASTIC			GREASE or OIL	
E40017436PRD	40017436	GEARCASE CAP	Enhanced Plastic Cap for Grease Style Gearcases					



Also Offering **Original**
Design Grease & Oil
GearCases - PLOCK



Call Our Team for Pricing
and Availability!



**“Uniting Innovation, Engineering,
Manufacturing and Distribution”**



GE GEARCASES

REF. #	DESCRIPTION	TM	RATIO	LOCOMOTIVES	LUBE
41D731910G2 46756697G2	UPPER GEARCASE	E8	74:18	B23 -7, M630, U18B, U23B, U25C, U25B, U30B, U30C, U33C, U36C, C -424	GREASE
41D731910G8 6756697G3	LOWER GEARCASE	E8	74:18	B23 -7, M630, U18B, U23B, U25C, U25B, U30B, U30C, U33C, U36C, C -424	GREASE
41D731910G7 or G9 6756697G1 or G11	SET GEARCASE	E8	74:18	B23 -7, M630, U18B, U23B, U25C, U25B, U30B, U30C, U33C, U36C, C -424	GREASE
41D732358P1 41D732364G2	UPPER GEARCASE	AF	83:20	C30 -7, C30 -7A, C36 -7, C39 -8, C40 -8, C40 -8M, C40 -8, C40 -9, DASH 8 -32B	GREASE
41D732358P1 41D732364G3	LOWER GEARCASE	AF	83:20	C30 -7, C30 -7A, C36 -7, C39 -8, C40 -8, C40 -8M, C40 -8, C40 -9, DASH 8 -32B	GREASE
41D732364G1	SET GEARCASE	AF	83:20	C30 -7, C30 -7A, C36 -7, C39 -8, C40 -8, C40 -8M, C40 -8, C40 -9, DASH 8 -32B	GREASE
41D735356P1 41D735347P2	UPPER GEARCASE	AG	83:20	C40 -8 (Reminder: An AG will fit an AF)	OIL
41D735868P1	LOWER GEARCASE	AG	83:20	C40 -8 (Reminder: An AG will fit an AF)	OIL
41D735359G3 Or 41D735668G1	SET GEARCASE	AG	83:20	C40 -8 (Reminder: An AG will fit an AF)	OIL
41D735347P2	UPPER GEARCASE	AH	83:20	C40 -CW, GE DASH 9'S	OIL
41D735340P6 41D735797P1	LOWER GEARCASE	AH	83:20	C40 -CW, GE DASH 9'S	OIL
41D735315G3	SET GEARCASE	AH	83:20	C40 -CW, GE DASH 9'S	OIL
41D730230G1 Or G3 970X21 41D732863G3	SET GEARCASE	761	NARROW GAGE	Set's Only 1 1/2" - 6 thread w/ caps Sets Only 1"-8 thread w/ caps	GREASE
41D735642P1	LOWER GEARCASE AMTRAK	AH	83:20	P40 - P42	OIL
41D735644P1	UPPER GEARCASE AMTRAK	AH	83:20	P40 - P42	OIL
41D735428G1	UPPER GEARCASE	761	NARROW GAGE	A22, 23, or 24	GREASE
41D735428G2	LOWER GEARCASE	761	NARROW GAGE	A22, 23, or 24	GREASE
41D736089G3	UPPER GEARCASE	C44			OIL
41D736091G1	LOWER GEARCASE	C44			OIL
41D7366091G5	LOWER GEARCASE	C44		SUPERCEDED BY 41D7366091G6	OIL
41B538243P1 41AA230409G3	GE CAP	BASE MADE WITH GALVANIZED STEEL WITH RUBBER SEAL			

**Also Offering Original
Design Grease & Oil
GearCases - PLOCK**



**Call Our Team for Pricing
and Availability!**



*“Uniting Innovation, Engineering,
Manufacturing and Distribution”*



GEAR CASE SEALS

Complete Line of Gear Case Seals, Wicks Lubricators, Caps and Dust Guards

E40017436
Enhanced Cap



E8126036 - Strap



E9535375 - E9535376
Enhanced Seal



E40061419 - Seal Kit

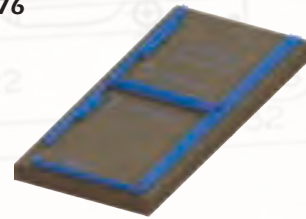

E8277771
Wicks



E9569938 - Grease



E40012790
Seal



E8407506
Seal

E8322027



E40017457
Honey Oil



Full line of Huck
Bolts



40007174
Pinion Seal



8032750 Locknut

8322026 Washer

108659 Cotter Pin

OIL CAP ENHANCEMENT

Redesigned Location and Seal Material to Stop Leaks.

Traction Motors
Journal Box



Seal Repositioned under Head
for Secured Seal.

Upgrade YellowSeal™

Higher Volume Lower Cost!!!!

- E9333024
- E9324109
- G41A238534P1

- 3/4" Yellow
- 1" White
- 3/4" White



See Page 123 for Our
Locomotive Hyatt/GG
Wheel Sets



See Page 104 for Premium
Brass Support Bearings





*“Uniting Innovation, Engineering,
Manufacturing and Distribution”*



GENERATORS - MAIN AND AUXILIARY

Complete Line of New & **True Blue™** Main & Auxiliary Generators and Exciters

OEM Ref. #	Description	New	UX
5553414 8405875	10Kw Aux Gen	Yes	Yes
8405875MOD	14Kw Aux Gen	Yes	Yes
8122750	18Kw DC Aux Gen	Yes	Yes
4979844	18Kw AC Aux Gen	Yes	Yes
9551383	18Kw AC Aux Gen	Yes	Yes
9533149	18Kw AC Aux Gen	Yes	Yes
3195473	24Kw AC Aux Gen	Yes	Yes
D12	Main Generator	No	Yes
D15	Main Generator	No	Yes
D22	Main Generator	No	Yes
D32B & D32P	Main Generator	No	Yes
D32E & D32E1	Main Generator	No	Yes
AR10	Main Alternator	No	Yes
AR11	Main Alternator	No	Yes
AR15 - AR17	Main Alternator	No	Yes
AR20	Main Alternator	No	Yes



***NEW AUX GENs
IN STOCK!**



GENERATOR SHAFT DRIVES

E8184471 - 5 7/8" OAL

E8476944 - 15 5/8" OAL

OEM Ref. #	Description	New	UX
GY27L2	Auxiliary Generator	No	Yes
GY27M2	Auxiliary Generator	No	Yes
581	Auxiliary Generator	No	Yes
586	Auxiliary Generator	No	Yes
598	Auxiliary Generator	No	Yes
GTA9	Main Alternator	No	Yes
GTA11	Main Alternator	No	Yes
GTA15	Main Alternator	No	Yes
GTA16	Main Alternator	No	Yes



E8195996
Coupling



E8234958 Compression
Bushing or 16185106
Generator Bushing



POWERRAIL

CREATIVE INNOVATIONS ... CONTINUING TRADITION



*"Uniting Innovation, Engineering,
Manufacturing and Distribution"*



HANDRAIL - CARBODY

Complete Line of New Handrails and Related Deck Products



HEATERS

Complete Line of Heaters including Free Standing, Wall Mounted and Sidewall.



PowerRail P/N	Description	Comments
P5006B Series	Free Standing	3000W - 3750W - 4000W
E40012336	Free Standing Stock Model	3000 Watt with Top Defrost With Sidewall Circuit Panel
E40001549	Free Standing Stock Model	3000 Watt with Top Defrost NO Circuit Panel
PM5032	Wall Mounted	3000W - 3750W - 4000W
PM5002	Sidewall	Dual 660W & 1320W
PM5002-2	Sidewall Stock Model	Dual 750W & 1500W
PM5029	Control Switch	Dual Per Above
P24477	Circuit Breaker	65A 3 Pole
P21366	Heater Motor	5/16" Dia. Single Shaft
P21134	Heater Motor	5/8" Dia. Single Shaft
P20605-1	Heater Motor	5/16" Dia. Dual Shaft
P21159	Heater Motor	5/16" Dia. Dual Shaft
P24442-1	Heater Brush	2 per Set
P31118	Junction Box	Wall Heater
P31005	3 Position Switch	Junction Box

HORN COVERS

Complete Line of both Cloth and Stainless Air Horn Covers to provide protection from the Weather and Elements



PowerRail Ref. #

- Cover Blue 4 3/4"
- Cover Blue 6 1/4"
- Cover Blue 8"
- Cover Blue 9"
- Cover Blue 11"
- Cover Set K3SET
- Cover Set K5SET
- P36935
- P36945

Application

- Cloth - Air Horn Bell
- Cloth - Air Horn Bell
- Cloth - Air Horn Bell
- Cloth - Air Horn Bell
- Cloth - Air Horn Bell
- Cloth - Air Horn Set 3 Chime
- Cloth - Air Horn Set 5 Chime
- CDF Stainless 3 Chime
- CDF Stainless 5 Chime



Please See Page 29 for Air Horns





HOSE - AIR

New line of AAR Air Hose and other related
Air Brake components



**Actuating Application & Release 1/2" Male NPT
AAR M-618 LS4 Gladhand**



<u>PowerRail P/N</u>	<u>Overall Length</u>	<u>Hose Size</u>
HAL5880	34"	3/4 (1/2)
HAL5217	36"	3/4 (1/2)

Note: Above are Common Hoses - We offer a full Line
from 25" to 36" OAL

**Main Reservoir 1" Male NPT
AAR M-618 LS4 Gladhand**



<u>PowerRail P/N</u>	<u>Overall Length</u>	<u>Hose Size</u>
MRL5064	34"	1 1/8
MRL5209	35 1/2"	1 1/8
MRL5640	36"	1 1/8

Note: Above are Common Hoses - We offer a full Line
from 25" to 43"

**Train Line 1 3/8" Hose 1 1/4" Male NPT
AAR M-601 FP5 Gladhand**



<u>PowerRail P/N</u>	<u>Overall Length</u>	<u>Hose Size</u>
HFR12422	22"	1 3/8
HFR12433	33"	1 3/8

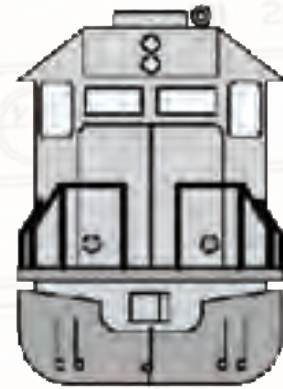

Actuating, Application Release and Sanding
Equalizing
Trainline
Main Reservoir
Actuating, Application Release and Sanding

**1-1/4" MALE PIPE THREAD X 1-1/4"
MALE PIPE THREAD - AAR M-601**

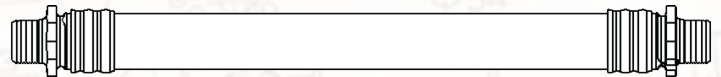

<u>PowerRail P/N</u>	<u>Overall Length</u>	<u>Hose Size</u>
N777733	26-1/8"	1 1/8
N779362	27"	1 1/8
N777583	28 1/8"	1 1/8
N777734	37 1/8"	1 1/8
N777866	59 1/8"	1 1/8

Gaskets - Gladhand & Flange Style Hoses



<u>PowerRail P/N</u>	<u>OEM Ref#</u>	<u>Comment</u>
W563952	739882	FS5 Gasket
N73103	Car Hose	1/2" Flange
N731034	Car Hose	3/4" Flange
N731056	Car Hose	1" Flange
N731061	Car Hose	1 1/4" Flange





*"Uniting Innovation, Engineering,
Manufacturing and Distribution"*



DUMMY HOSES

Complete Line of Dummy Hoses & Flanges



PowerRail P/N	Overall Length	Hose Size
N777356	12-5/8"	1 1/8
N777355	15 1/8"	1 1/8
N777357	16 5/8"	1 1/8
N777358	17 5/8"	1 1/8
N777889	27 5/8"	1 1/8



PowerRail P/N	Type	Vent Holes	Chain Length
N739823	F	Yes	No
N703124	F	Yes	7 1/2"
N77/8839	F	Yes	18"
N739709	F	No	No
N700303	F	No	7 1/2"
N781168	F	No	10"
N780690	F	No	12"
N739824	H	Yes	No
N703123	H	Yes	7 1/2"
N756979	H	Yes	14"
N739822	H	Yes	33 1/2"
N739710	H	No	No
N700304	H	No	7 1/2"
N739825	L&E	Yes	No
N703125	L&E	Yes	7 1/2"
N703406	L&E	Yes	16"

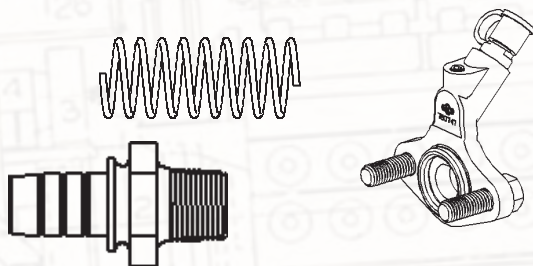

HOSES AIR

Complete Line of Freight Care Hose

Broad Line of Freight Car Hoses AAR M-601 & M618
Approved. Please call us for more information
on replacement Air Hose Parts

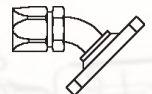
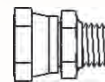
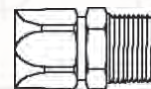
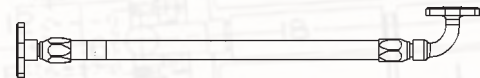
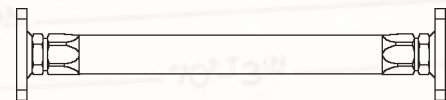
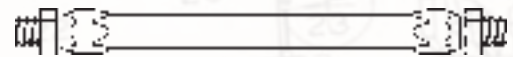

- Male to Male
- Male to Female
- Female to Female
- Flange
- Wire Re-Enforced
- Swivel Fittings
- Coil Guards
- Full Line of Adaptors

HOSE STRAP

AAR 4006 High Strength Synthetic Strap



PowerRail Part# NY778117



POWERRAIL

CREATIVE INNOVATIONS ... CONTINUING TRADITION



*"Uniting Innovation, Engineering,
Manufacturing and Distribution"*



HEAT SHIELDS

Complete Line Of Heat Shields



PowerRail P/N

E40089234
E40089235
E40089236
E40089237
E40089238
E40109698
E8351251
E8351254
E8358827

Application

SD70 Right Rear
SD70 Left Rear
SD70 Right and Left Front
SD70 Right and Left Front
SD70 Left Front and Right Rear
SD70 Z Type
Intermediate Rear Left Hand
SD70 Right and Left Front
Rear Left Hand

The above list is a sample of the heat shields we offer.

HOSE SAND

"Safe Sand" Gold Series

New Generation Utilizing Cloth Weave Technology
Eliminating Wire Related Injuries



PowerRail P/N

Description

Hose Size

E8328950	50 Ft. Roll Sand Hose	1 5/16
E9097530	25 Ft. Roll Sand Hose	1 5/16

See Page 96 for All Sand Related Items

HOSE

Full Line of Engine Related Fuel,
Oil and Air Hoses



PowerRail P/N

E9320120
E9320121
E9320122
E9319341
E9319342
E8155981
G140X2954
G140X1553
G140X2935

Application















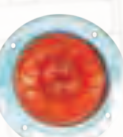
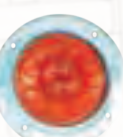

Detector to Water Pump
Detector to Water Pump
Detector to Water Crankcase
Governor Oil Drain
Lube Oil
Wiper
Fuel
Turbo Oil Feed
Oil Drain

HOUSINGS

Complete Line of Ditch, Headlight, Step Light ,
MU Housings and Receptacles.

PowerRail P/N

Application

E8650814	Ditch Light Housing	
E40043668	Ditch Light	
G41B549606P1	Ditch Light	
E8235852	Headlight Vert. & Horz. Mount	
E8332339	Headlight Vertical Mount With shield	
E40046500	Headlight Dual SD70	
E8382662	Contact MU	
E8079302	Cover - MU Receptacle	
E9572733	MU Dummy Receptacle	
G84A201176P3	MU Dummy Receptacle with back plate	
E8242444	Receptacle MU Complete	
E8004092	Step Light Assembly	
G41A200358P1	Step Light Assembly	
E10590984	Step Light Assembly	
E10605432	FRA Red Lens Light Assembly	
G41A205337ABP2	Light Assembly Clear Lens	
E40016750	Brake Light Indicator	

HOSE - CUSTOM KITTING

Full Line of Special Kits that can be customized
to any requirement



POWERRAIL

CREATIVE INNOVATIONS ... CONTINUING TRADITION



*“Uniting Innovation, Engineering,
Manufacturing and Distribution”*



INJECTORS

Complete line of New and Re-Manufactured Fuel Injectors

OEM Ref#	Comment
5229500/9081163	567B/567BC
5229290/8478048	567C
5229510/9081164	567D
5229200/8478045	645E
5229250/8478046	645E3
5229320/8478053	645E3B
5229335/8478055	645E3B Eco
5226210/9561950	645F3B
123X1110-2	7FDL
132X1710	Bryce Single Pump
132X1645	Bryce Double Pump
132X1715	Bendix Single Pump
132X1535	Bendix Double Pump



Full Line of Injector Parts

ECOTIP “Green Tag” Injectors

OEM Ref #	ECOTIP Ref #	Comment
5229295/8478049	40083527/40078996	567 A,B,BC,C,E Fuel Efficient Tip
5229200/8478045	40083524/40078993	645E Roots Fuel Efficient Tip With Calibration Slide
5229250/8478046	40083525/40078994	111 Fuel Injector 12,16, 20 Cylinder Low Smoke
5229335/8478055	40083533/40079002	111 Fuel Injector Fits 645E3B

Green Tag Injectors Offer Very Precise Beginning and Ending Of Fuel Injection. This Results In Fuel Savings At Full Load and On Medium Duty Cycle. Reliability and Durability Is Also Increased Due To Lower Peak Cylinder Combustion.



E8431626 Holding Rack For Injectors



“Black Tag” Extended Idle “Switcher” Injectors

Black Tag P/N	Engine Application	Body Style
4991632	567B, BC, C	No-line
4991635	567C	1 Narrow groove
4991629	645E, 567C	1 Narrow groove

Black Tag Injectors Are Designed To Overcome Specific Challenges Under Various Applications. The Benefits Include Reduced Emissions, NOx and Smoke With Minimal To No Fuel Penalty In Certain Applications. The Injectors Also Help To Reduce “Souping” During Extended Idle Situations.





*"Uniting Innovation, Engineering,
Manufacturing and Distribution"*



JOURNAL BOXES - HYATT & ROLLER WHEEL BEARINGS

Complete Line of AAR Quality New and Re-Manufacture Hyatt Journal Boxes,
Conversion Boxes and Tapered Bearings

We Offer True Unit Exchange or R&R Programs



Hyatt W/3N1 Liner

PowerRail P/N

- E7476217
- E7476218
- E7476218-3PC
- E7476218MOD

Application

- Hyatt Journal Box 6 1/2 x 11
- Hyatt Journal Box 6 1/2 x 12 Standard 3N1 Liner
- Hyatt Journal Box 6 1/2 x 12 3-Piece Lug Liner
- 6 1/2 x 12 Modified for GG Bearing



All Hyatt Boxes are Modified
with the 3N1 Liner Standard



All Hyatt Boxes are Modified
with the 3N1 Liner Standard

New and Unit Exchange GG Style Boxes

- | | |
|---------------|----------------------------|
| E9539650 | GG Adaptor Box (9580195) |
| E9539431 | Lateral Pad |
| PRD16184305 | Lateral Pad 1/8" Undersize |
| G41D7277667G5 | GG Adaptor Box |

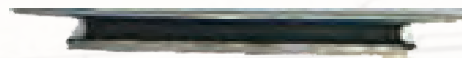

9539431 Lateral Pad

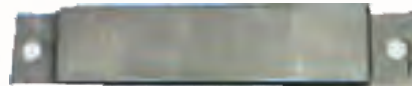

Offering a Full Line of Modified Boxes



POWERRAIL
CREATIVE INNOVATIONS ... CONTINUING TRADITION



*"Uniting Innovation, Engineering,
Manufacturing and Distribution"*



- E7482827 Cover w/Pipe Plug
- E7491289 Cover with Axle Gen Hole
- E8148707 Adaptor Extension for Axle Generator
- E9529931 Bracket Shock Lower
- E9529903 Bracket Shock 3 Axle



E7491289



E8148707



112192



E9529931



E9529903



Fig A



Fig B

Journal Box Shims

PowerRail #	Application	PowerRail #	Application
E8455980 (Fig A)	1/8 Inch	E8455982 (Fig B)	1 Inch
E8177292 (Fig A)	3/8 Inch	E8112192 (Fig B)	1 1/4 Inch
E8455981 (Fig B)	1/2 Inch	E8455983 (Fig B)	1 1/2 Inch
E8044686 (Fig B)	3/4 Inch	E8223384 (Fig B)	1 3/4 Inch

Full Line of Remanufactured Locomotive & Freight Bearings



Type	Size	Capacity - Tons
D	5 1/2 x 10	50 - Passenger
E	6 x 11	70 - Passenger
F	6 1/2 x 12	100 - Passenger
G	7 x 12	125
EE	5 1/2 or 6	Passenger
GG	6 1/2 or 6 7/8	Locomotive



Remanufactured Locomotive Swing Hangers





*“Uniting Innovation, Engineering,
Manufacturing and Distribution”*



OTHER RELATED STOCKED LOCOMOTIVE TRUCK COMPONENTS

LATCHES - DOOR, CABINET & ENGINE

Complete Offering of Latches and Keys for Doors including Modesty Locks and Carbody



LEVERS - HANGERS & BRAKE RELATED PARTS

Complete Line of Components for Locomotive Trucks



PowerRail P/N	Application	PowerRail P/N	Application
E9500246	Brake	E40033871	Guide
E9500247	Brake	E8441548	Guide
E8160062	Brake	E40033873	Guide
E9098135	Brake	E8466631	Guide
E8044914	Brake	E8157951	Hanger
E8044915	Brake	E8389488	Hanger Inside
E8107338	Brake	E8044912	Hanger Inside
E8107339	Brake	E8441551	Hanger Inside
E8044911	Brake	E8401941	Hanger Outside
E8157951	Brake Hanger	E8044911	Hanger Outside
E8099416	Connection Strap, OE or Modified 42" Wheel	E8475110	Hanger Outside
		E8160062	Inside Yoke Brake
		E8334026	Outside Yoke Brake
E8465284	Connection Strap, OE or Modified 42" Wheel	E8334027	Outside Yoke Brake
		E8044913	Strap
E40034696	Cylinder	E8228267	Strap
E40034694	Cylinder	E8228266	Strap
E40035166	Cylinder		
E40035154	Cylinder		



PowerRail P/N	Application
E8048966	SW Trucks - Inner Ring
E8025096	SW Trucks - Outer Ring
E8024365	SW Trucks - Traction Motor Air Duct
E8277771	SW Trucks - Wick Assembly
E8104189	OE Holder, Suspension Unit
E8339952	OE Suspension Pack
E9334248	SW/GP/SD Trucks - Traction Motor Suspension Assembly
E9324108	SW/GP/SD Trucks - Pedestal Liner
E40010820	SW/GP/SD Trucks - Pedestal Liner Kit with Fastener
E8068060	GP Trucks - Bolster Wear Plate
E9085368	GP Trucks - Center Plate Liner (Bolster)
E9329633	GP Trucks - Center Plate 1/2 Ring (Bolster)
E9548794	GP Trucks - 3/8" thick Center Bowl Liner (1 Piece)
E9562813	GP Trucks - 1/2" thick Center Bowl Liner (1 Piece)
E8044697	GP Trucks - Upper Swing Hanger Bearing Block
E8044698	GP Trucks - Lower Swing Hanger Bearing Block
E8106539	GP Trucks - Elliptic Spring Nest Assembly
E8354463	GP Trucks - Elliptic Spring Nest Assembly
E9568083	GP Trucks - Elliptic Spring Nest Assembly (Low Profile)
E9085317	GP Trucks - Double Coil Journal Spring Assembly
E8020225	GP/SD Trucks - Traction Motor Air Duct
E40020765	GP/SD Trucks - Journal Spring Pad



POWERRAIL

CREATIVE INNOVATIONS ... CONTINUING TRADITION



*"Uniting Innovation, Engineering,
Manufacturing and Distribution"*



Megger

Complete Offering of Electrical
and Electric Measuring Equipment

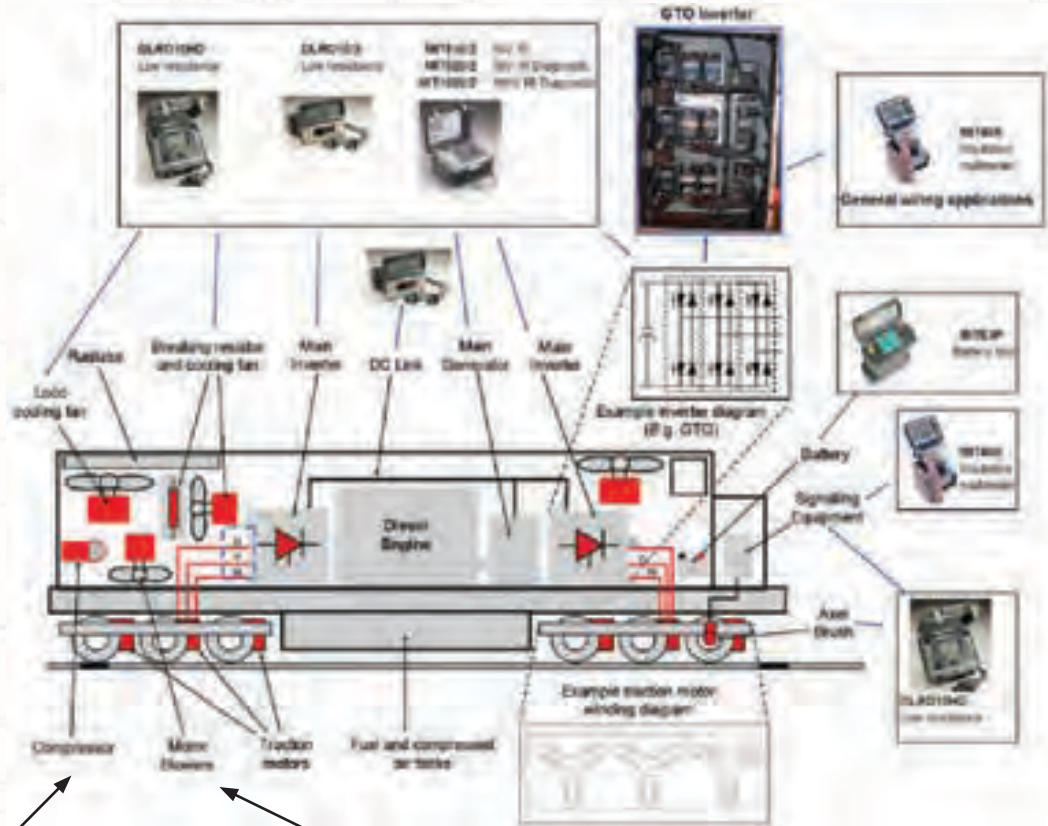

DRO200 - MIT 5kV & 10kV



DL10 Low Resistance



Improved 5 and 10kV insulation testers

- Smaller size and lighter weight
- Easier to use
- Rotary switch dial
- Unique dual case design
- Intuitive operation
- Ramp test
- 3mA output power
- Accuracy where it matters most
- Super fast battery charge





*"Uniting Innovation, Engineering,
Manufacturing and Distribution"*



MODULES

Complete Line of Electronic Modules, Cards and Panels



OEM Ref. #	Description
AN17	ANNUNCIATOR
DE12	DYNAMIC BRAKE EXT. RANGE CONTROL
DG12	DYNAMIC BRAKE GRID PROTECTION
DP12	DYNAMIC BRAKE PROTECTION
DR20	DYNAMIC BRAKE REGULATOR
EL11	EXCITATION LIMIT CONTROL
GV12	GENERATOR VOLT REGULATOR
GX12	GENERATOR EXCITATION REGULATOR
PF17	PERFORMANCE CONTROL
PF29	PERFORMANCE CONTROL
RC12	RATE CONTROL
SA10	SAND CONTROL
SB11	SENSOR BY-PASS MAX PERFORMANCE
SE13	SENSOR
TH14	THROTTLE RESP & VOLT REFERENCE
TR12	TRANSITION CONTROL
VR14	VOLTAGE REGULATOR
WS10	WHEEL SLIP

NAME PLATE & NUMBERING

Complete Line of Nameplates, Locomotive Numbers & Signs of All Shapes & construction



GE 17FD and 17FL Series - Blue Electronic Cards Regulators and Complete Aux Panels



Other Popular Signs
Please Visit our Website for Full Catalog
WWW.EPowerRail.Com

Description	Sign Size	PowerRail #
Sign Engine Water Drain Inside	3 x 9	PP50035-131
Sign Emergency Brake Valve	4 3/8 x 8 3/8	PP50035-59
Sign Engine Water Fill	4 3/8 x 8 3/8	PP50035-6
Sign Emergency Fuel Cut-Out	2 1/2 x 6	PP50035-61
Sign Danger 600 Volt	4 3/8 x 8 3/8	PP50035-67
Sign Emergency First Aid Kit	5 x 11	PP50035-7
Sign Fire Extinguisher Inside	6 x 12	PP50035-72
Sign Sanitary Drain Pipe	4 7/8 x 9 1/8	PP50035-9

We will Custom Manufacture any Sign





**“Uniting Innovation, Engineering,
Manufacturing and Distribution”**



PINION BULL GEARS

Complete Line of New Pinion Bull Gears & Traction Gears,
as well as a complete line of High Quality Engine Gears



S. No.	OEM-REF	Bull Gear	Gear Part Nos.	S. No.	Pinion	Pinion Part Nos.
--------	---------	-----------	----------------	--------	--------	------------------

EMD Traction Gears & Pinions

1	EMD	Gear - 65 tooth	8178812	2	PINION Gear - 12 tooth D77	8452310
3	EMD	Gear - 63 tooth	8402408	4	PINION Gear - 14 tooth D77	9556207
5	EMD	Gear - 62 tooth	40049185 / 8109579	6	PINION Gear - 15 tooth D77	40006705
7	EMD	Gear - 61 tooth	40049661 / 8184341	8	PINION Gear - 16 tooth D77	9556208
9	EMD	Gear - 60 tooth	40049660 / 8179295	10	PINION Gear - 17 tooth D77	9556209
11	EMD	Gear - 59 tooth	8184333	12	PINION Gear - 18 tooth D77	9556210
13	EMD	Gear - 58 tooth	40049658 / 8184378	14	PINION Gear - 19 tooth D77	9556211
15	EMD	Gear - 57 tooth	8184325 / 40049657	16	PINION Gear - 20 tooth D77	9556212
17	EMD	Gear - 56 tooth	8184396	18	PINION Gear - 21 tooth D77	9556213
19	EMD	Gear - 55 tooth	8184342	20	PINION Gear - 22 tooth D77	9556214
21	EMD	Gear - 52 tooth	8184332	22	PINION Gear - 25 tooth D77	9556215
23	EMD	Gear - 63 tooth	40051136 / 40051133	24	PINION Gear - 14 tooth D31	8179135
25	EMD	Gear - 62 tooth	40051132	26	PINION Gear - 15 tooth D31	8459295
27	EMD	Gear - 60 tooth		28	PINION Gear - 17 tooth D31	8206504
29	EMD	Gear - 58 tooth	40051126	30	PINION Gear - 15 tooth D29	8458508
31	EMD	Gear - 57 tooth	40051125	32	PINION Gear - 16 tooth D29	8341961
33	EMD	Gear - 70 tooth	40012160	34	PINION Gear - 17 tooth D87	40006706
35	EMD	Gear - 69 tooth	40049648	36	PINION Gear - 18 tooth D87	9332201
37	EMD	Gear - 67 tooth	40049648	39	PINION Gear - 19 tooth D87	9332202
40	EMD	Gear - 66 tooth	40049647	41	PINION Gear - 20 tooth D87	9332203

GE Traction Gear & Pinions

1	GE	Gear - 90 tooth	41C637598P1	2	PINION 21 Tooth	41C637595P1
3	GE	Gear - 91 tooth	8837760 / 41B530121P1	4	PINION 20 Tooth	84C614969P1
5	GE	Gear - 92 tooth	41C632784P2 / 8837724	6	PINION 19 Tooth	41C632785P2
7	GE	Gear - 93 tooth	41C636682P1 / 88377526P1	8	PINION 18 Tooth	41C635677P2 / 41C637903P1
9	GE	Gear - 94 tooth	41C637211P1 / 8837727P1	10	PINION 17 Tooth	41C637180P1
1	GE	Gear - 65 tooth	41C635820P1	2	PINION 18 Tooth	41C635796P1
3	GE	Gear - 74 tooth	41C632494P1	4	PINION 18 Tooth	41C637399P1
5	GE	Gear - 77 tooth	41C632350P1	6	PINION 26 Tooth	41C632349P1
7	GE	Gear - 83 tooth	41C636806P1	8	PINION 20 Tooth	41C636447P6
9	GE	Gear - 87 tooth	41D735826P2	10	PINION 16 Tooth	41D735825P1
11	GE	Gear - 90 tooth	41C632381P1	12	PINION 17 Tooth	41C632382P1
13	GE	Gear - 83 tooth	41C637055P6	14	PINION 20 Tooth	84C62083492

GE Alt. Gears & Pinions

1	GE	Drive Gear 102T	41C637055P6	2	PINION 43 Tooth	41C635625P1
3	GE	Drive Gear 102T	41C637055P6	4	PINION 43 Tooth	41C635800P1
5	GE	Drive Gear 102T	41C637055P6	6	PINION 43 Tooth	41C632663P1

EMD Engine Gears

1	EMD	Drive Gear 58T	8483944	2	EMD	Drive Gear 79T	8069019
3	EMD	Drive Gear 58T	8483945	4	EMD	Drive Gear 79T	8069014
5	EMD	Drive Gear 79T	8360843	6	EMD	Drive Gear 265T	8416930
7	EMD	Drive Gear 113T	8360839 / 8141909				



POWERRAIL

CREATIVE INNOVATIONS ... CONTINUING TRADITION



*“Uniting Innovation, Engineering,
Manufacturing and Distribution”*



PIPE CLAMP BRACKETS

Complete Line of Pipe Clamp Brackets



Ref #	Pipe O.D.	Length	Pipe or Tube
8108110	1/4"	2 1/2"	Tube
8108299	1/4"	4"	Tube
8108111	3/8"	2 1/2"	Tube
8108118	3/8"	4 1/2"	Pipe
8108202	3/8"	4 5/16"	Tube
8108113	1/2"	2 1/2"	Tube
8108115	1/2"	3"	Pipe
8108116	1/2"	3"	Pipe
9329413	1/2"	3"	Pipe
8108125	1/2"	3"	Pipe
8108117	1/2"	3 7/8"	Pipe
8108206	1/2"	4"	Tube
8104470	1/2"	4"	Pipe
8108114	5/8"	2 3/4"	Tube
8108209	5/8"	4 1/2"	Tube
8108126	3/4"	3 1/4"	Pipe
8327561	1"	3 1/2"	Pipe
8108127	1"	3 1/2"	Pipe
8108129	1 1/2"	4 3/8"	Pipe



Ref #	Pipe O.D.	Length	Pipe or Tube
8108201	1/4"	8 1/4"	Tube
8108118	3/8"	4 1/2"	Pipe
8108202	3/8"	4 5/16"	Tube
9318029	3/8"	5 9/16"	Tube
8236518	3/8"	6 5/16"	Tube
8236518	3/8"	6 5/16"	Tube
8108197	1/2"	6 5/8"	Pipe
8108208	1/2"	8 3/8"	Tube
8155268	1/2"	8 5/8"	Pipe
8108209	5/8"	4 1/2"	Tube
8108211	5/8"	8 7/16"	Tube
8108214	3/4"	8 3/4"	Tube
8108217	1"	8"	Pipe
8108219	1 1/4"	4 1/2"	Pipe
8108129	1 1/2"	4 3/8"	Pipe
8108241	2 1/2"	7 5/8"	Pipe



**PRIME MFG—SUN VISORS, MIRRORS,
ENGINE PROTECTORS
AND RECIRCULATING TOILETS**

Complete Line of Prime Manufacturing Components



PowerRail P/N	Description
Engine Protectors	See Page 64
E9550240	Sun Visor - Ball Mounted
E9331382	Sun Visor - Straight Mount
E40006334	Sun Visor - Straight Mount
E8370302	Mirror with Bottom Deflector
SC875-32	Mirror Right or Left Mount General Purpose Switchers - Road Units
E9573201	Mirror Engineer 5 x 8" Left Hand
E9573200	Mirror Engineer 5 x 8" Right Hand
PM118-5	Toilet Stainless Steel





*"Uniting Innovation, Engineering,
Manufacturing and Distribution"*



**General
ThermoDynamics**
A ThermoSys Company

- OEM approved Design and Quality
- ISO certified and Caterpillar Bronze Certified
- Tier 1 EPA Certified Products
- Custom Design and Manufacturing Strengths
- Extended Warranty

**HEAT EXCHANGERS
RADIATORS, OIL COOLERS, PRE-HEATERS,
INTERCOOLERS AND AFTER-COOLERS**

Complete Line of New OEM Grade and
"True Blue™" Unit Exchange Heat Exchangers

PowerRail P/N	Description
E40036275	Single 6 Row
E40017114	Triple 6 Row
E40017115	Double 6 Row
D4MB	Double 4 Row
T4MB	Triple 4 Row
S8MB	Single 8 Row
D8MB	Double 8 Row
T8MB	Triple 8 Row
Quad8	Quad 8 Row
G41D711033G10	31 " Radiator No Tanks
G41D701689P2	31 " Radiator With Tanks
G41D712040G4	42 " Radiator No Tanks
G41R971400G9	42 " Radiator With Tanks



PowerRail P/N	Description
E9544027	SW1500 Bundle Tubes
E9339040	4" MB Oil Cooler Core
E8364030	4" MB Oil Cooler Core WITH Case
E9514842	6" MB Oil Cooler Core
E9558515	6" MB Oil Cooler Core WITH Case
E9577200	PreHeater - Standard GP Style 60K
E40057079	PreHeater 60K BTU SD70
G84D702217P1	PreHeater
E8288974	10 Row AfterCooler 2 Pass 2 Flange
E8409891	10 Row AfterCooler 2 Pass 2 Flange
E40020885	12 Row AfterCooler 4 Pass 2 Flange
E40113591	12 Row AfterCooler 4 Pass 4 Flange
G128X1649	Intercooler Right - Long
G128X1650	Intercooler Left - Long
G128X1692	Intercooler Right - Short
G128X1693	Intercooler - Left Short
E9087321	Radiator Cap 2 Prong
E9323490	Radiator Cap 3 Prong
E9338780	Rad Cap 3 Prong 20PSI
E8039994	2 5/8" X 8" Rad Hose

EMERGENCY

**E8386654 Emergency Leak Stopper
0.75OZ Containers in Stock**



**PRD16184458 Coolant Test Kit
Rust Inhibitor**

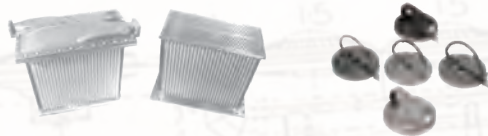

PRMIF
Unit Exchange
"True Blue™" Series



Mechanical Bonding Heads

Mechanical Head Completed

Pressure & Leak Tested
Quality is Job 1

POWERRAIL
CREATIVE INNOVATIONS ... CONTINUING TRADITION



*“Uniting Innovation, Engineering,
Manufacturing and Distribution”*



**PINS - BUSHINGS - SLEEVES
CLEVIS - LINERS, ETC.**



CAB SUPPORT ITEMS

Complete Line of Cab Support Items including
Refrigerators, Fans and Hotplates

PowerRail #	Application
ME4130 1.5 Cu Inch ME4170 2.5 Cu Inch	Stainless Refrigerator 110Volt with Bulit In Invertor
ME804	Cab Fan 74 VDC Single or Dual Sped
PMC945G	1000W 3 Switch 10" Dia.
E9509437	Cup Handset Hangup
E8145407	Coat Hook

PRESSURE SWITCHES

Complete Line of New and Unit Exchange Pressure
Switches, Sensors, Transducers and Valves



RESISTOR GRIDS

Complete Line of Braking Resistor Grids.

OEM REF #	Resistance
8304194, 40085144	.927 Ohms
8304193, 40085145	.860 Ohms
8347464, 40085146	.922 Ohms
8339532	1.072 Ohms
8339533	.970 Ohms
9337613	.642 Ohms
9337614	.689 Ohms
9331050, 9191050	.923 Ohms
9331051	860 Ohms
8185703, 40085141	.660 Ohms
8185704, 40085142	.660 Ohms
8185705, 40085143	.690 Ohms
8190834	.690 Ohms

OEM REF #	Resistance
40010556	.860 Ohms
40010557	.860 Ohms
40010558	965 Ohms
40010559	.632 Ohms
40010560	.766 Ohm



***Please Contact Us On Our
GE Style Grids**





*“Uniting Innovation, Engineering,
Manufacturing and Distribution”*



ROOTS BLOWERS

Complete Line of New and **“True Blue™”** series
Roots Blowers Remanufactured by
PowerRail Manufacturing



***New Roots Blowers Are Also Available**



All Scrolls Are Precision Balanced

PowerRail #	Application
E8379666UX	Roots - Right Hand
E8379667UX	Roots - Left Hand



**All Rebuilt Roots Blowers
are Bench Tested**

PowerRail’s “True Blue™” Series



E8189438 Housing



E8028594 Quill Shaft



E8206553 Bearing



E8369675 Bearing



E8028466
Thrust Washer



E8204451 End Plate



E8065752 Gear Cover



POWERRAIL
CREATIVE INNOVATIONS ... CONTINUING TRADITION



*“Uniting Innovation, Engineering,
Manufacturing and Distribution”*



ROCKER ARMS AND VALVE BRIDGES

Complete Line of New and **“True Blue™”** Rocker Arms and Valve Bridges
for 567, 645 and 710 Type Engines

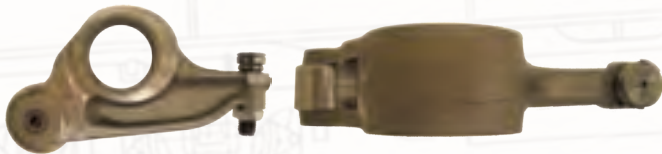

567 Light Injector - E8456128

567 Light Exhaust - E8328694

645 Injector - E9319504 or E9319504HH

645 Exhaust - E9319505 or E9319504HH



645 Heavy Heavy Complete Set - E40052184HH



E8085260 - Valve Bridge Old Style

E40126370/40145929 - Valve Bridge New Style



Replacement Parts

E8054088 Bridge

E8068791 Spring

E8028126 Seat

E8028136 Ring

E8052307 Button

E8085254 Lash Adjuster



POWERRAIL

CREATIVE INNOVATIONS ... CONTINUING TRADITION



*“Uniting Innovation, Engineering,
Manufacturing and Distribution”*



SAND NOZZLES

Complete Line of Sand Nozzles



PowerRail P/N	Description	Application
E8328553	Sanding Nozzle	EMD Style
E8328938	Sanding Nozzle	EMD Style
G84C615855P1	Sanding Nozzle	GE Style
G41C625615P1	Sanding Nozzle	GE Style
G41B545256P1	Sanding Nozzle	GE Style



SAND RELATED

Complete Line of Sand Related Support Items

PowerRail P/N	Sand Valves
E8320347	Shut-Off No Flange
E8320349	Shut Off With Flange
E9097530	Sand Hose 25 Foot
E8328950	Sand Hose 50 Foot
E8374760	Sand Hose Clamp
E8348109	Sand Trap 1 1/4 Inch
E8498335	Sand Valve Relay



PowerRail P/N	Description	Application
E8355568	Universal Guide Left	EMD & GE
E8355569	Universal Guide Right	EMD & GE
E8133933	Sand Pipe Guide	Left Front
E8133932	Sand Pipe Guide	Right Front
E8269587	Sand Trap	EMD Style
E8349902	Sand Trap	EMD Style
E8350356	Sand Trap	EMD Style
E10539205	Sander Guide Assembly	EMD Style

***Special Designs Available If Required**

SAFETY LINE

Complete Line of Safety Products



Bumpers Pg. 34



Safetymatters



Safety Handles - Color Code Pg. 32



FRA Tape Pg. 97



Light Weight Bio Salt Pg. 45

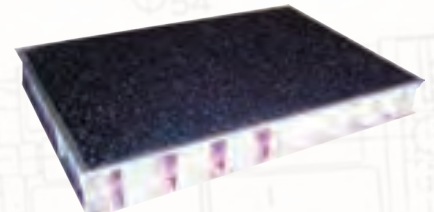

Locomotive Flooring Pg. 53



Starter Safety Sling Pg. 98





**“Uniting Innovation, Engineering,
Manufacturing and Distribution”**



SAFETY CONES

Exclusively Manufactured for PowerRail
Customized to suit Rail Requirements



**Lime or Orange
Plain No Strip
3M One Strip
3M Dual Strip**

18" with 3 Lbs Base

28" with 7 Lb Base

36" with 10 Lb Base

SAFETY VESTS

Manufactured for PowerRail for Rail Industry Safety



- ANSI/ISEA 1007-2004 Class 2 Certified
- 5 Point Tear Away for Snagging Safety
 - 100% Flame Resistant
 - 3M Reflective Strips
 - Washable

***5 Velcro points on vest allow for easy removal if caught in mechanical operation tear-away points on each shoulder, each side, and in the center.**

SAFETY DRAIN MAT

Seals drains, grates, sewer, etc. against Fuel and Chemical Spills. Durable, Impact resistant 100% Polyurethane.



36" x 36" x 1/2"
Standard Size
Custom Sizes &
Rolls Available



We also carry
Emergency Spill Kits

Rail Version 3 1/4 Lbs
Lightweight for rapid
response and ease
of operation

SAFETY - WORK GLOVES

Complete Line of Work Gloves for Any
Application and Protection



Rubber



Leather



Mechanics

SAFETY - FIRST AID KIT

First Aid Kit For Any Onboard
Accidents and Injuries



SAFETY - HEARING PROTECTION

Premium Hearing Protection for
Demanding Applications

- Innovative Flexible Bands offers Better Fit & Greater Comfort
- Optimal Band Size "One Size Fits All"
- Optimal Fit & Hearing Protection with 3 sets of Buds for precise Ear fits
- Durable Construction for Durability and Contamination Resistant



SAFETY - FRA-224 REFLECTIVE TAPE

Complete Line of 3M® FRA Tape



- 4" x 150 Foot Rolls
- Kiss Cut or Continuous Roll
- White - Yellow - Fluorescent Yellow Colors



POWERRAIL

CREATIVE INNOVATIONS ... CONTINUING TRADITION



*“Uniting Innovation, Engineering,
Manufacturing and Distribution”*



SAFETY LINE

Complete Line of Track Mats and Pad



Track Mat - Coldform 2

- **PRD16185004-19**
 - 19”x100’ for outside of track
 - Qty 1 - 1 case (2 rolls per case)
- **PRD16185004-57**
 - 57” x 100’ for inside of track
 - Qty 1 - 1 case (1 roll per case)
- **PRD16185004-SET**
 - 1 case of both sizes



Sorbent Socks Maintenance & Oil Only

- **PRD16185036-O**
 - 3 Inch Diameter x 4 Foot Length
 - 30 socks per case
 - WHITE - absorbs oil only
- **PRD16185036-WO**
 - 3 Inch Diameter x 4 Foot Length
 - 30 socks per case
 - GREY - absorbs oil and water



Sorbent Pads and Rolls Oil-Only Medium Weight

- **PRD16185035-PAD**
 - 15 inch x 18 inch pad
 - 100 pads per case
 - WHITE - absorbs oil only
- **PRD16185035-ROLL**
 - 30 inch x 150 roll
 - WHITE - absorbs oil only



Sorbent Pads and Rolls Maintenance Med. Weight

- **PRD16185034-PAD**
 - 15 inch x 18 inch pad
 - 100 pads per case
 - GREY - absorbs oil and water
- **PRD16185034-ROLL**
 - 30 inch x 150 roll
 - GREY - absorbs oil and water

SAFETY STARTER SLING

Our Starter Safety Sling has been designed to help make replacement of locomotive starters both a Safe and Efficient practice

Starter Safety Sling Features

- 400 LB Weight Capacity
 - Heat Resistant Up To 360° F & Chemical Resistant
 - X-Pattern Stitching For Extra Reinforcement
 - Safety Yellow Material
- Our sling can be used on all 32 and 64 volt starters

P/N PRD16184407



Safety Lift



Safety Install



Safety Release



POWERRAIL

CREATIVE INNOVATIONS ... CONTINUING TRADITION



*“Uniting Innovation, Engineering,
Manufacturing and Distribution”*



SAFETY LINE

Complete Line of Sure-Foot Inc. Products

Facility Safety

Facility Safety Solution for Facility Worn Stairs. Our **PowerSafe** Aluminum Treads Install over Damaged or Unsecure steps



Before



After

**PowerSafe
Solution
Provided**

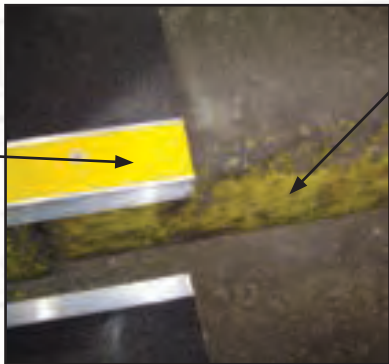

**Damaged
Concrete
Step**

Custom Made for ANY Size Step

PowerSafe

Custom Made for Any
Locomotive Pit
Up to 10 Foot Lengths

ANY WIDTH

Visually Enhances
Dangerous Areas



Safety matters

Locomotive Safety

Introducing the **PowerSafe** Safety Aluminum Treads design
Exclusively for Injury Prevention on Locomotives

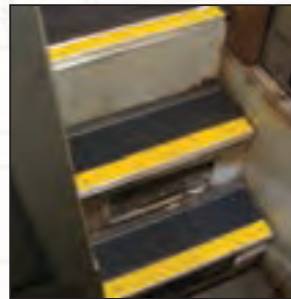

SD70AC Cab Steps



SD70AC Engineer Side

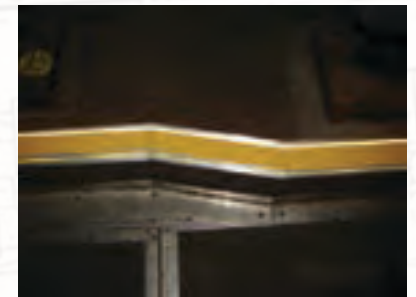

SD70AC Conductor Side

DESIGNED AS KITS

Other Sure-Foot Products

**Safety Adhesive
Back Tread Signs**



POWERRAIL

CREATIVE INNOVATIONS ... CONTINUING TRADITION



SEATS

Complete Line of OEM Seats for Switchers

- Narrower, shorter seat for Switcher applications
- Rugged heavy-gauge tubular steel construction
- Infinitely adjustable backrest angle
- 2-Way adjustable lumbar support
- Fire-resistant black vinyl material
- Full foam bolsters W/contoured lumbar support
- Integral spring supported cushion for shock isolation
- 6-Inch fore and aft seat adjustment



PowerRail #	Application
P183049CD37	Switcher Mid Back Standard
P183049CD37ARM	Switcher Mid Back With Arm
P180837	Ultra Low Back
P180837ARM	Ultra Low Back With Arm

SEATS

Complete Line of OEM Seats for Road Units

- Rugged heavy-gauge tubular steel
- 2-way adjustable lumbar support
- Infinitely adjustable backrest angle
- Fire-resistant Vinyl Material (Cloth Optional)
- Cushion rake angle adjustment
- 2-inch forward adjustment on seat cushion
- Full foam bolsters with contoured lumbar support
- Integral spring supported cushion for shock isolation
- 9-inch fore-and-aft seat adjustment
- ABS plastic back protector W/placard attached



PowerRail #	Application
P180109CD37	High Back Non Sleeper
P176025PS	Floor Mount 4" Height Adjustment
P178241PS	Wall Mount With Swivel 3" Height

SLACK ADJUSTERS

Complete Line of Locomotive Slack Adjusters and Brake Rigging

PowerRail #	Application
E9334230	SW Style
E9334229	GP Style Clasp Brake
E40042095	GP Style
E40039040	SD Style
E40039041	SD Style
G41C619252G1	GE
G41C612181G1	GE
G41C614411G2	GE



PowerRail #	Application
E8465284	Connection Strap, OE or Mod. 42" Wheels
E8099416	Connection Strap, OE or Mod. 42" Wheels
E8044913	Switcher - 2 or 3 Hole Strap
E9527279	GP Trucks, Single Shoe Brakes
E9516057	Slack Adjuster Assembly, Long
E9513003	Slack Adjuster Assembly, Short

SPRINGS

Complete Line of Coil Springs and Leaf Springs



*Common Stock Items

PowerRail #	Application
E9549172	Double Coil
E8228050	Double SD40
E8057051	Spring Outer
E8057052	Inner Middle
E8057053	Spring Inner
E8106539	Elliptical Leaf Spring Set of 4
E8229325	Elliptical Leaf Spring





*“Uniting Innovation, Engineering,
Manufacturing and Distribution”*



SNUBBERS - SHOCK ABSORBERS - DAMPERS

Complete Line of Shock Absorbers and Snubbers manufactured by Enidine & Koni

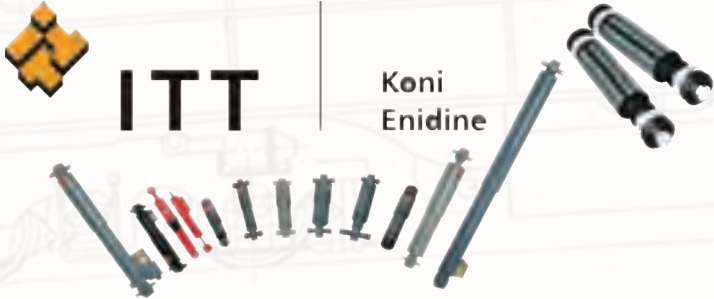

Common Stock Items

PowerRail P/N	Description
E4974695	Shock Lateral
E4993721	Shock
E40020355	Damper Yaw
E40031527/40087597	Shock Combo End
E40122566	Damper
E40086732	Damper
E40088065	Damper Yaw
E40153054	Damper Vertical
E40153061	Snubber
E40153062/22012514	Shock
G41A244100AAP	Snubber
G41C624176P1	Snubber
G41A319100P	Damper Axle
G41A319101P	Damper Lateral
G41A319102P	Damper Vertical

Also Carry Shock Mount Plates



SPARK ARRESTORS

Complete Line of Spark Arrestors For Any Locomotive. Custom or Standard Design



Locomotive Spark Arrestors

PowerRail P/N	Application	Qty Required
10AC8	EMD SW-1	1
10AC10	EMD NW-2	2
10AC10	EMD NW-5	2
10AC12	EMD SW-8	1
10AC10	EMD SW7/9	2
10AC12LP	EMD SW-900	1
10AC12LP	EMD SW-1200	2
12AC12LP	EMD SD-7	2
12AC12LP	EMD SD-9	2
12AC12LP	EMD E-7	2
12AC12LP	EMD E-8	2
12AC12LP	EMD E-9	2
12AC12LP	EMD GP7	2
12AC12LP	EMD GP9	2
10AC10	EMD GP10	4
12AC12LP	EMD GP18	2
12AC12LP	EMD GP28	2
12AC12LP	EMD GP38	2

Call for Details





*"Uniting Innovation, Engineering,
Manufacturing and Distribution"*



**Starters are Failing Premature Due
to The AESS Application**

STARTER MOTORS

Complete Line of New and our **"True Blue™"**
Series Unit Exchange Starter Motors Utilizing
OEM Delco Remy Enhanced Parts

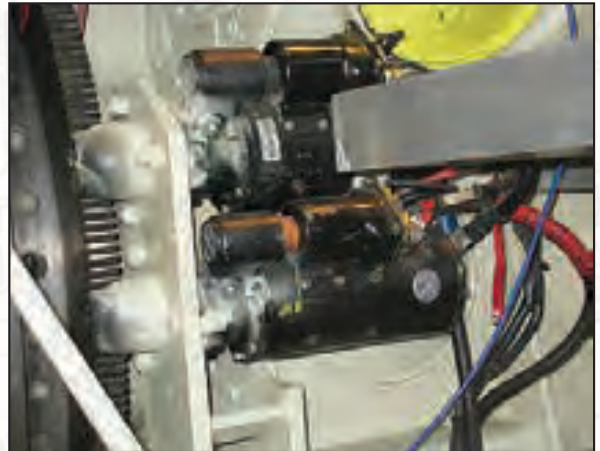
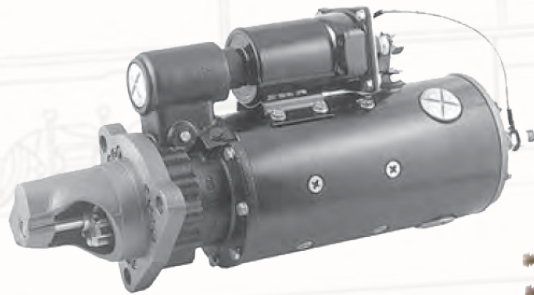

AESS Enhancement

- **Special Brushholder**
- **Heavier Copper Armature**
- **Special High Current Solenoid**
- **Special Copper Brushes**

PowerRail P/N

Description

E8384834/E1990333	32 Volt Starter
E8384834/E1990333AESS	32Volt Starter for AESS
E8428605/E1993740	64 Volt Starter
E8428605/E1993740AESS	64 Volt Starter for AESS
E10478827/E40069492AESS	32 Volt AESS Starter SD70



**The UNIQUE Austart Air Starters are
proven in Rail, Marine, Mining, Power
Generation, Drilling and Gas Compression
markets with great results holding up under
the most demanding environments.**



Call us for our Full Line
of Air Starters
New OEM Style, Light weight
Low Air consumption.



E8387359PRD

Starter Cover
Ask about our Enhanced
Starter Shield



E9358874
Starter Bracket



POWERRAIL
CREATIVE INNOVATIONS ... CONTINUING TRADITION



*“Uniting Innovation, Engineering,
Manufacturing and Distribution”*



**SNOW PLOW
TRACTION MOTOR BRASS**

“PowerBlade” manufactured by Avoca Rail Products
Universal Design fits most Locomotives



100% USA built at a competitive price.

SUPPORTS - HANDRAILS, FEET AND BRACKETS
Complete Line of Supports, Handrails, Feet and Brackets

PowerRail P/N	Description
E9092557	Support Handrail 23.50"
E8258472	Support Handrail 36.75"
E8361180	Support Handrail 36.75"
E8368491	Support Handrail 41.75"
E8379948	Support Handrail 41.75"
E8379949	Support Handrail 41.75"
E8379953	Support Handrail 41.75"
E9553636	Support Handrail 41.75"
E8313482	Support Handrail 43.75"
E8331857	Support Handrail 43.75"
E8355621	Support Handrail 43.75"
E8216378	Support Handrail 45.75"
E8304234	Support Handrail 45.75"
E8344827	Support Handrail 49.375"
E8379950	Support Handrail 51.375"
E8379951	Support Handrail 51.375"
E8389882	Support Handrail 52.75"
E8313798	Support Handrail 53.375"
E8331849	Support Handrail 54.75"
E8315142	Support Handrail 56.75"
E8379947	Support Handrail 56.75"



**We Also Offer a Full Line
of Treads And Steps**





*"Uniting Innovation, Engineering,
Manufacturing and Distribution"*



SHIMS AND SPACERS

Complete Line of Shims
and Spacers



PowerRail P/N	Description
G41A210731P4	.062" Shim Air Compressor
E8478477	Shim Axle Cap
E40014450	.031" Shim Bearing Flange For Combo's
E8061581	.015" Shim Bearing to Bracket
E8083559	.020" Shim Bearing Plate
E8156922	Shim 11 Gauge
E8159285	.063" Main Generator Mounting
E8159286	.125" Generator Mounting
E8178082	.004" Shim Roots Blower
E8194923	.625" Frame Cover and Support
E8348671	.014" AR10 Shim
E8478477	.010" Shim Axle Cap
E8348667	AR10 11Ga
E8348668	AR10 16Ga
E8348669	AR10 20 Ga
E8348670	AR10 24 Ga
E8348671	AR10 0.14"
E8348672	AR10 .005"

**SUPPORT BEARING -
TRACTION MOTOR BRASS**

Complete Line of Premium Brass
Support Bearings



PowerRail P/N	Description
E9557789	8" Standard
E9557790	8" 1/32" U.S.
E9557791	8" 1/16" U.S.
E9557792	8" 3/32" U.S.
E9557793	8" 1/8" U.S.
E9557794	8" Std. 1/32" OS Flange
E9557797	8 1/4" Standard
E9557798	8 1/4" 1/32" U.S.
E9557799	8 1/4" 1/16" U.S.
E9557800	8 1/4" 3/32" U.S.
E9557801	8 1/4" 1/8" U.S.
G41B535757G6	9" Standard
G41B535757G7	9" 1/32" U.S.
G41B535757G8	9" 1/16" U.S.
G41B535757G9	9" 1/8" U.S.
G41B535757G10	9" 3/16" U.S.



**Call for Details on
Our PowerBrass
Cost Reduction
Program.**

**Significant \$\$\$ Savings
\$\$\$ for NEW BRASS**





**“Uniting Innovation, Engineering,
Manufacturing and Distribution”**



SWITCHES

Complete Line of Switches

PowerRail P/N	Description
E8296748	Switch Roller Button 1NC - Throttle - Single End Faston Connection
E8296750	Switch Slide Roller Button - Controller Mechanism - Single End Faston
E8296752	Switch Roller Button 1NC - Controller Mechanism - Single End Faston
E8330133	Slide Switch Button Generator Field 1 NO with Double End Faston
E8330137	Slide Switch NO - Lights Engine Room, HV Cab Walkway
E8455355	Slide Switch 2 NO - Ditch Light With Seal Wire
E9097525	Slide Switch - 1 NO and 1 NC with Single End Faston Tab - Start, Head Light
E8481166	Slide Switch - 1 NO with Double End Faston Tab Connections - Light
E9333939	Slide Switch - 2 NO - Fuel Pump - With Double End Faston Tab Connections
E9096836	Rocker Switch-Double Pole, Single Throw
E8299162	Roller Switch-Manual Roller Lever 10A 120VDC
E8117872	Pressure Switch-Open at 20lbs, Closed at 35lbs.
E8301186	Pressure Switch—Cut in 130PSI, Cut Out 140PSI
E8334998	Pressure Switch-Cut in 10 PSI, Cut Out 15 PSI
E8340775	Pressure Switch-Open at 40lbs, Closed at 20lbs
E8425022	Pressure Switch-1st Stage, Open at 130PSI, Closed at 140 PSI 2nd Stage-Open at 135 PSI, Closed at 145 PSI.
E8425056	Pressure Switch-3 Pole Receptacle
E8283936	Temperature Switch—In at 170°, Out at 155°
E8424290	Temperature Switch-In at 174°, Out at 159°
E8425575	Temperature Switch-In at 215°, Out at 205°
E8457270	Temperature Switch-In at 175°, Out at 160°
E8457492	Temperature Switch-In at 185°, Out at 170°



***The Above List is a Sample of The Switches We Offer.**





**“Uniting Innovation, Engineering,
Manufacturing and Distribution”**



SWITCHES - ROTARY

Complete Line of Rotary Switches

PowerRail P/N	Description
E8204906	Cab Heater 4 Position 1 Pole 10A 125V
E8351224	Cab Heater 4 Position 1 Pole 10A 125V
E8276486	Cab Heater 4 Position 3 Pole 10A 125V
E8238108	Signal Light 4 Position 8 Pole 10 Amp 125 V.A.C.
E8314947	Sequence Test Panel 2 Position 8 Pole 10 Amp 125 V.A.C.
E8272931	Sequence Test Panel 3 Position 5 Pole 10 Amp 125 V.A.C.
E8440928	Module Test Panel 3 Position 5 Pole 20 Amp 600 V
E8332070	Fuel Prime and Engine Start 3 Position 4 Pole 10 Amp 125 V.A.C.
E834625	Fuel Prime and Engine Start 3 Position 5 Pole 10 Amp 125 VAC
E8441983	Fuel Prime and Engine Start 3 Position 6 Pole 20 Amp 600 V
E8242197	Headlight 2 Position 4 Pole 30 Amp 250 V.A.C
E8277638	A,C, Terminal Light 2 Position 2 Pole 30 Amp 250 V.A.C.
E8287557	Signal Light 2 Position 5 Pole 30 Amp 250 V.A.C
E8238109	Remote Head Light 4 Position 4 Pole 30 Amp 250 V.A.C
E8370683	Manual Power Red 3 Position 3 Pole 10 Amp 125 V.A.C.
E8345702	Traction Motor Cut-Out Switch 4 Position 10 Amp 125 V.D.C.
E8336232	Traction Motor Cut-Out Switch 5 Position 10 Amp 125 VDC
E8348980	Traction Motor Cut-Out Switch 5 Position 10 Amp 125 V.A.C.
E8332834	Hostlers Control Switch 1 Position 10 Amp. 74 V.D.C,
G41A313736P2	SBM Rotary Switch
G41A313738P1	3 Position Rotary Switch



Rotary Switch Handles	
PowerRail P/N	Description
E8189077	Switch Handle 1/4" O.D. Shaft
E8168346	Screw For Rotary Swtich Handle 1/8-40 x 11/32
E8168328	Pin For Rotary Switch 3-48 x 1/2"
E131181	Washer Lock #6

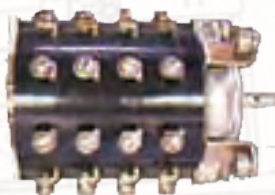



SWITCHES - ROTARY

Complete Line of Rotary Switches

PowerRail P/N	Description
E8356487	Traction Motor Cut-Out Switch 4 Position 10 Amp 125 V.A.C.
E8435590	Signal Light 2 Position 1 Pole 30A 125V
E8460767	Remote Headlight 3 Position 1 Pole 30A 230V
E9083195	Ac Terminal Light 2 Position 2 Pole 30A 500V
E8298939	Heater 3 Position 2 Pole 30A 230V
E8237656	Directional Headlight 5 Position 2 Pole 30A 230V
E8485569	Slug Control 2 Position 4 Pole 10A 125V
E8437642	Heater 4 Position 4 Pole 30A 74V
E8484926	Heater 4 Position 4 Pole 30A 125V
E8243533	Remote Headlight 4 Position 4 Pole 30A 230V
E6923315	Unit Selector 4 Position 4 Pole 30A 500V
E8439118	Remote Headlight 4 Position 4 Pole 45A 600V
E8422024	Heater 8 Position 5 Pole 30A 230V
E8206315	Isolation 2 Position 6 Pole 30A 500V
E6916566	Isolation 2 Position 8 Pole 30A 500V
E8330988	Isolation 2 Position 8 Pole 30A 500V
E8433191	Isolation 2 Position 9 Pole 45A 600V
E8484096	Isolation 2 Position 10 Pole 45A 600V
E10589900	Rotary Snap 5 Position 2 Pole
G41A314126P1	Motor Cutout Rotary Switch
G84A201850P11	Headlight Rotary Switch



Rotary Switch Handles	
PowerRail P/N	Description
E8193318	Switch Handle 3/8" O.D. Shaft
E132037	Screw For Rotary Switch Handle 10-24 x 7/16"
E8193814	Pin For Rotary Switch 1/8 x 3/4"
E8256115	Washer Lock #10





*"Uniting Innovation, Engineering,
Manufacturing and Distribution"*



TRUCK - SWING HANGERS

Complete Line of **"True Blue™"** Unit Exchange
AAR Certified Remanufactured Swing Hangers
and Related parts from **Cooper Bearings**
in Georgetown, Delaware

**New & Remanned
Locomotive
Swing Hangers**

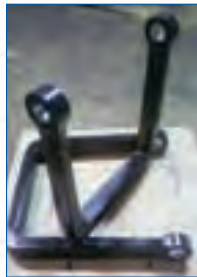

We Also Offer NEW Swing Hangers

PowerRail P/N

Description

E8044697	Upper Bearing Block
E8044698	Lower Bearing Block
E8068056	Bushing 2.250" x 2.754" x 1.375"
E8102087	Bushing 2.250" x 2.750" x 2.250"
E8309537	Bushing 2.250" x 2.758" x 2.250"
E8309538	Bushing 2.250" x 2.780" x 2.250"
E8309539	Bushing 2.250" x 2.800" x 2.250"
E8078796	Pin Drilled Both Ends 1 1/2" x 10"

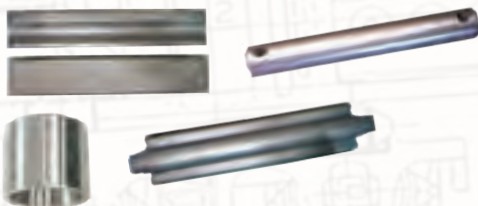

TRUCK - SWING HANGERS

Complete Line of **"True Blue™"** Unit Exchange
AAR Certified Remanufactured Trucks from
PowerRail Locomotive Services
in Monroe, Georgia



**Hyatt or GG Bearings
Single or Clasp Brake Shoes - Spring Bolster
GP TRUCK - BLOMBERG**



**Hyatt or GG Bearings Single or Clasp Brake Shoes
Suspension Pad Bolster
GP - BLOMBERG M**



**Friction or Roller Bearing - Duplex Brake Cylinder
EMD SWITCHER TRUCK**



POWERRAIL
CREATIVE INNOVATIONS ... CONTINUING TRADITION

***TRUCKS IN STOCK
IMMEDIATE DELIVERY***



TERMINAL BOARDS

Complete Line Terminal Boards
for all Electrical Applications



PowerRail #	Connection Type	Tabs
E8298162	Fast-On Single Sided	4
E8434754	Fast-On Single Sided	6
E8467946	Fast-On Single Sided	8
E8287076	Fast-On Single Sided	12
E8283970	Fast-On Single Sided	15
E8410147	Fast-On Single Sided	16
E8277744	Fast-On Single Sided	20
E8324824	Fast-On Single Sided	22
E8292938	Fast-On Single Sided	24
E8368473	Fast-On Single Sided	24
E9331353	Fast-On Double Sided	20
E9507683	Bolted Double Sided	8
E8354091	Bolted Single Sided	8
E8422649	Bolted Single Sided	12





**"Uniting Innovation, Engineering,
Manufacturing and Distribution"**



TOOLS

Complete Line of Tools

*This is just a sample of the tools we offer.
Please visit www.ePowerRail.com or call us today for many more.

T50031

The T50031 kit was designed to make the job of torquing crab nuts easier while providing accurate torque results. It is comparable to our E8408219

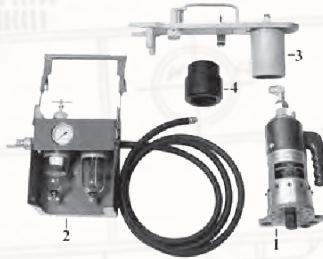

T57870-115V

The T57870-115V offer excellent and uniform torquing of EMD Style power assembly crab nuts. It comes with a 1 1/8" hydraulic powered electric driven power unit rated at 9,000 PSI. It also comes with a 25 feet hose assembly, two wheel cart, and two socket torque. The wrench head is adjustable from 500 to 3,500 lb. ft. of torque.

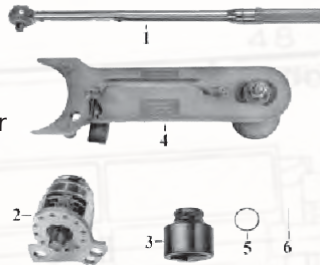

T54101

Crab Nut Tool

The T54101 is the manual kit for torquing EMD Style crab nuts.



T57211 Tool and T57211B for Bolts EMD Style Power Assembly Break Loose Jacking Tool

E8075894

Cylinder Head Puller



8417858

Lifter Power Assembly



E8116358

Lifter Cylinder Liner



E8171633PRD

Carrier Snap Ring Enhancement



E8239562

Installer/Remove Bushing



E8243341

Hand Tool Breaker Traction Motor Leads



E8243341

PRD Enhanced 2-Piece



E8339610

Rack Setting



8432485

Jack Governor Injector



E87170

C Frame Tool
Power Asslys Compressor
Aux. Generators





*"Uniting Innovation, Engineering,
Manufacturing and Distribution"*

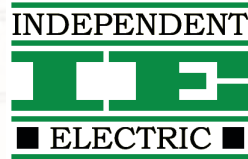

TRACTION MOTORS

Complete Line of "True Blue™" Series
Traction Motors Re-Manufactured
by **PowerRail Independent Electric**
in Lyons, Kansas. We also offer a Full Line
of Unit Exchange Combo's

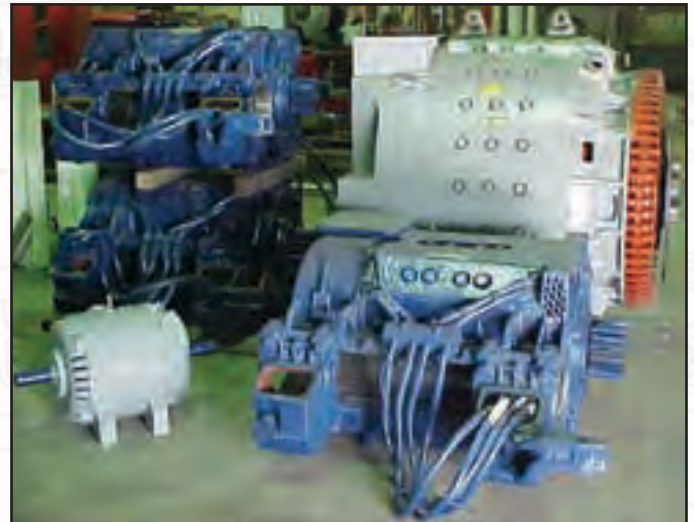

**Shortline & Premium Rebuilds in Stock
for Immediate Delivery**



- Class 1 Approved
- Internationally Approved
- Regionals & Shortline Approved
- Quality M-1003 approved Parts
- Quality Workmanship
- Experienced Staff
- Technical Support
- Competitive Price
- Full Line Support Products

D27/D37/D47	D57/D67	D77/D77B	D78	D87/D87B	D90
752E6	752E8	752 AF	752AG	752AH	GEB





*"Uniting Innovation, Engineering,
Manufacturing and Distribution"*



TRACTION MOTORS NEW

Complete Line of **100% New GE & EMD Style**
Traction Motors Manufactured by
PowerRail— Rail & Traction Canada



Rail & Traction Canada



Utilizing our M-1003 AAR OEM Verification Process



SolidWorks CAD System Engineering Staff

- Product Development
- Enhanced Designs
- Failure Analysis

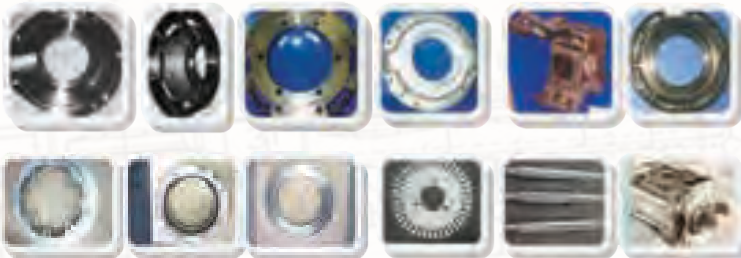
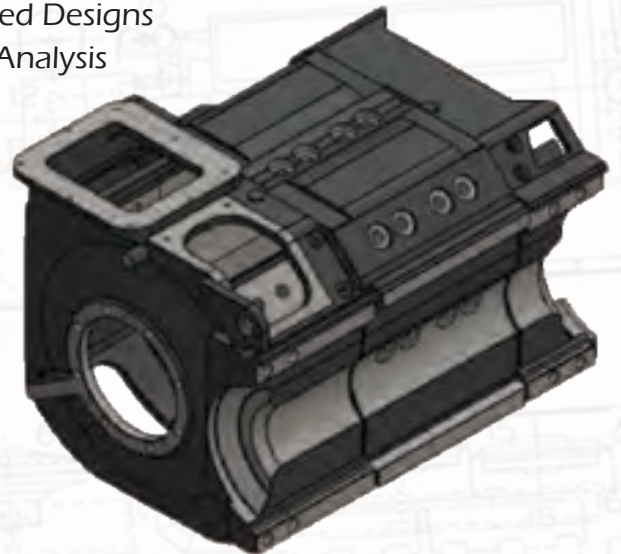

Railroading Together Into the Future



- Axle Caps
- Bearing Caps & Housings
- Flingers & Seals
- Frames
- Shafts
- Commutator & Armature
- Shims Spacers Sleeves Laminations



POWERRAIL

CREATIVE INNOVATIONS ... CONTINUING TRADITION



*"Uniting Innovation, Engineering,
Manufacturing and Distribution"*

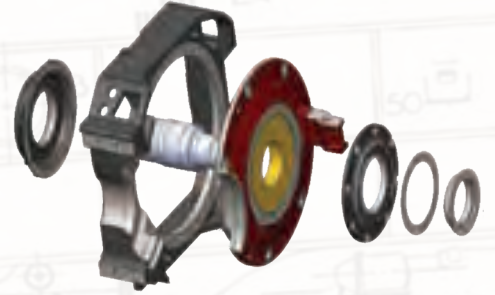
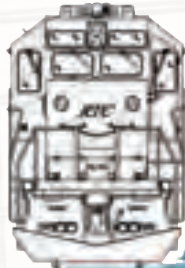

RTC
Rail & Traction Canada



Narrow



Gauge BTR or Axle Cap

Standard



Gauge BTR or Axle Cap



Eliminate Brass & Wick

***Significant Cost/Labor Savings**

**Competitive cost for converting
Brass Support to BTR U Tube
Design using New
and or remanned
components.**



**Note: The above images are similar in appearance. Please see our disclaimer stating we are not offering Genuine OEM parts or components. We are not an Authorized OEM. All parts are manufactured by or vendors of PowerRail.*





*“Uniting Innovation, Engineering,
Manufacturing and Distribution”*



Rail & Traction Canada

GE Style



GE – Models Domestic

5GE747, 5GE751, 5GE752, 5GE761,
5GE763, 5GE764

GE – Models Internationally

731 and 761 Series GE – Models



*Note: The above images are similar in appearance. Please see our disclaimer stating we are not offering Genuine OEM parts or components. We are not an Authorized OEM. All parts are manufactured by or vendors of PowerRail.





*"Uniting Innovation, Engineering,
Manufacturing and Distribution"*



RAIL & TRACTION CANADA

Complete Line of Electrical Rotating Parts and Components that support Generators, Alternators, Traction Motors and other related equipment
A PowerRail Company

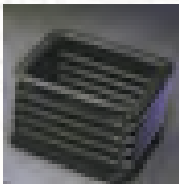
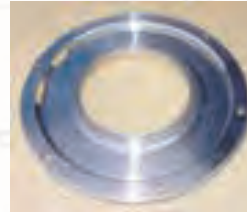



*“Uniting Innovation, Engineering,
Manufacturing and Distribution”*



Common Production Stock Parts
EMD D77 Traction Motor Support Items



PowerRail P/N	Description
E8104188	Nose Support Plate
E8104189/E9087386	Nose Spring Holder Pack
E8126036	Safety Strap
E8322027	T-Bolt Safety Strap
E8326203	Gearcase Cap - Grease
E8407505	Clamp MS Gearcase
E40051181	Gearcase Install Kit Grease/Oil
E40061419	Gearcase Seal Oil
E40017436	Filler Cap
E8407506	Dust Guard CE

PowerRail P/N	Description
E9333024PRD	3/4" Oil Filler Cap - LEAK PROOF
E9324109PRD	1" Oil Filler Cap - LEAK PROOF
E8417729	D77 Brushholder
E9322058	D77 Carbon Brush
E9323317	Seal Ring Oil 8"
E8277771	Wick Lubricator
E9535375	Seal WS
E9535376	Seal MS
E40006705	15T Pinion - See Page 63
E40012790	Pinion Seal



PowerRail P/N	Description
E9583736	D77 Connector Crimp Type1325/24
E9583737	D77 Connector Crimp Type1100/24
E9583735	D77 Connector Crimp Type1480/24

PowerRail P/N	Description	PowerRail P/N	Description
E8341414	EMD Air Duct Assembly	E10661110	Insulator Sleeve
E8350968	TM Sleeve 1.5ID x 14 5/8 Lg	E10664863	SD70 Sleeve Insulating
E8194450	TM Sleeve 1.2ID x 12 1/2 Lg	E9520160	Rubber Faston
E8024365	EMD Switcher Air Duct	E9334248	Traction Nose Pack
E40111584	Cable Cleat D87/D90	E9096902	Sleeve Kit
E9094306	Cable Cleat D77	E8206883	Hi Temp Grommet
E8474056	Cable Cleat		
E9087386	Nose Pack Fabricated	G41B532099G1	GE 752 Cable Cleats
		E8243341	TM Cable Splitters





*“Uniting Innovation, Engineering,
Manufacturing and Distribution”*



**Common Production Stock Parts
GE 752 Traction Motor Support Items**

GE 752E8 Traction Motor

PowerRail P/N	Description
G41A238534P1	Oil Fill Cap
G41B535245G1	Seal Ring 9" Oil
G41B537189P1	Dust Seal ME
G41B537190P1	Gutter/Seal WS
G41B537191P1	Gutter/Seal ME
G41B537266P1	Dust Guard CE
G41B537963P1	Brush
G41C632068G1	Wicks Lubricator Only
G41D731488G1	Inspection Cover Bottom
G4748663G1	Inspection Cover Top
G160X1026	Gearcase Install Kit - Grease
41C632667G6	Brushholder - Radial
18T - 20T - 22T	Pinions - See Page 90

GE 752AG Traction Motor

PowerRail P/N	Description
G41A238534P1	Oil Fill Cap
G41B535245G1	Seal Ring 9" Oil
G41C636752P1	Gutter
G41C636752P1	Gutter
G41B537963P1	Brush
G41D711633P	GE 752AG Air Duct
G41C635696G1	Wicks Lubricators Assy Complete
G41C636159G23	Inspection Cover Bottom
G41C636160G2	Inspection Cover Bottom
G41C636881G1	Inspection Cover Top
G160X1067	Gearcase Install Kit - Oil
G41C632667G6	Brushholder - Radial
18T - 20T - 22T	Pinions - See Page 90

GE 752AF Traction Motor

PowerRail P/N	Description	PowerRail P/N	Description
G41A238534P1	Oil Fill Cap	G41C635696G1	Wicks Lubricator Assy
G41B535245G1	Seal Ring 9" Oil	G41C637106P1	Seal ME
G41B535795G1	Spring Cap - Grease	G41A235215P3	Clamp Dust Guard
G41B535882P2	Dust Seal Motor	G41D731488G1	Inspection Cover Bottom
G41B535883P2	Gutter Motor Side	G4748663G1	Inspection Cover Top
G41B535885P2	Gutter Wheel Side	G752AF-Set	Gearcase Install Kit - Grease
G41B537266P1	Dust Guard CE	G41C632667G	Brushholder Radial
G41B537307P1	Flinger Ring CE	G41C633771G2	Brushholder - Reaction
G41B537466P1	Lip Seal - Gearcase	18T - 20T - 22T	Pinions - See Page 63
G41B538243P1	Filler Cap	G160X1067	Gearcase Install Kit - Oil





TERMINAL LUGS

Complete Line of Terminal Lugs

Glad Hand Terminal Lugs

PowerRail P/N	Description
E8109922	0.938" ID, 775/24, 1100/24 Solder Type
E8160270	1.000" ID, 5.312 Long, 1325/24 Solder Type
E8137331	1.1875" ID, 5.312 Long, 1600/24 Solder Type
E9583737	.938" ID, 5.312 Long, 1100/24 Crimp Type
E9583736	.984" ID, 5.312 Long, 1325/24 Crimp Type
E9583735	1.030" ID, 5.312 Long, 1480/24 Crimp Type
E40028834	1.094" ID, 5.55 Long, 1600/24 Crimp Type

2 Hole Terminal Lugs

PowerRail P/N	Description
G41A201820P1	3 3/4" OD, 11/32 Bolt, 925/24 Cable
G8868241AAP1	2 15/16" OD, 5/15 Bolt, 113/27 Cable
G8868241AAP2	2 5/8" OD, 5/16 Bolt, 113/24 Cable
G8868241AAP14	3 3/16" OD, 5/16 Bolt, 550/24 Cable
G8868241AAP16	3 3/16" OD, 5/16 Bolt, 775/24 Cable
G8868241AAP17	3 3/4" OD, 3/8" Bolt, 925/24 Cable
G8868241AAP18	3 3/4" OD, 3/8" Bolt, 1100/24 Cable

Insulated Crimp Terminal Lugs with Stud Hole

PowerRail P/N	Description
E8123282	0.250" ID, 1/4" Stud Hole, Yellow, 12-18AWG
E8189218	0.170" ID, #6 Stud Hole, Blue, 14-18AWG
E8210498	0.170 ID, #10 Stud Hole, Blue, 14-18AWG
E8198189	0.170" ID, 1/4" Stud Hole, Blue, 14-18AWG
E8123281	0.170" ID, #10 Stud Hole, Yellow, 12-18AWG
E8123283	0.250" ID, 5/16" Stud Hole, Yellow, 12-18AWG
E8123284	0.250" ID, 3/8" Stud Hole, Yellow, 12-18AWG



Traction Motor Lugs



2 Hole Lugs

Non Insulated Crimp Terminal Lugs with Stud Hole

PowerRail P/N	Description
G41A265615P10	No 8 or 10 Stud, 10-22 Awg
E10634854	Tongue 12-14AWG, Yellow, #10 Stud Size
E8131368	0.284 ID, 3/8 Stud Hole, #4 AWG
E8269635	0.120" ID, #10 Stud Hole, 16-22AWG
E8281475	0.180" ID, #10 Stud Hole, 14-18AWG
E8282623	0.180" ID, 1/4" Stud Hole, 14-18AWG
E8292367	0.192" ID, 1/4" Stud Hole, 10-14AWG
E8292368	0.192" ID, #8/10 Stud Hole, 10-12AWG
E8301545	0.192" ID, 3/8" Stud Hole, 10-14AWG
E9098813	0.393" ID, 5/16" Stud Hole, 225/24 AWG

Non Insulated Crimp Terminal Lugs

PowerRail P/N	Description
E8118060	0.650 ID, Blank Stud Hole, 550/24 AWG
E8118061	0.762" ID, Blank Stud Hole, 775/24 AWG
E8118062	0.895" ID, Blank Stud Hole, 1100/24 AWG
E8160274	0.984" ID, Blank Stud Hole, 1325/24 AWG
E8352379	1.100" ID, Blank Stud Hole, 1600/24 AWG

Butt Connector Terminal Lugs

PowerRail P/N	Description
E8188705	0.984" ID, 4.625" Long, 1325/24
E8188705	0.984" ID x 4.625" Long, 1325/24
E8188706	1.100 ID x 1.340 x 4.62 Long, 1600/24

Battery Terminal Lugs

PowerRail P/N	Description
E8197509	0.880" ID, 13/32" Stud Hole, 4/0 Cable
E8211044	0.806" ID, 13/32 Hole, Flat Tongue 3/0 Wire
E8183110	0.880" ID, 13/32" Stud Hole, 4/0 Cable

This is just a sample of the terminal lugs we offer.

Please visit www.ePowerRail.com or call us today for many more.



Butt Connector Lugs



Gladhand Lugs



Traction Motor Lugs





**“Uniting Innovation, Engineering,
Manufacturing and Distribution”**



TRACTION MOTOR CABLES

Complete Line of traction motor cables available for shipment when necessary



PowerRail P/N	Description	Application
E9565453	Traction Motor Cable	No. 1 to No. 2 - 20 3/4" Long
E9565450	Traction Motor Cable	No. 1 to No. 2 - 21 3/4" Long
E8351147	Traction Motor Cable	No. 1 to No. 4
E8355704	Traction Motor Cable	No. 1 to No. 2
E9319807	Traction Motor Cable	No. 1 to No. 2 and No. 3. to No. 4
E9565451	Traction Motor Cable	No. 3 to No. 4 - 20 3/4" Long
E8355728	Traction Motor Cable	Cable Assembly "A"
E9319806	Traction Motor Cable	Cable Assembly "A"
E9566056	Traction Motor Cable	Cable Assembly "A"
E9566664	Traction Motor Cable	Cable Assembly "A"
E40017962	Traction Motor Cable	Cable Assembly "AA" 87" Long
E8141062	Traction Motor Cable	Lead Assembly "AA" 7' 2 1/2" Long
E9566057	Traction Motor Cable	Cable Assembly "AA" 7' 4 11/16" Long
E9566661	Traction Motor Cable	Cable Assembly "AA" 7' 4 11/16" Long
E8141063	Traction Motor Cable	Lead Assembly "F" 6' 10" Long
E40017961	Traction Motor Cable	Cable Assembly "F" 7' 5/8" Long
E9566058	Traction Motor Cable	Cable Assembly "F" - 7' 5/8" Long
E9566662	Traction Motor Cable	Cable Assembly "F" - 7' 5/8" Long
E40017963	Traction Motor Cable	Cable Assembly "FF" 76" Long
E8141064	Traction Motor Cable	Lead Assembly "FF" 6' 3" Long
E9566059	Traction Motor Cable	Cable Assembly "FF" - 6' 7 3/16" Long
E9566663	Traction Motor Cable	Cable Assembly "FF" - 6' 7 3/16" Long



New Flexible 3Kv Traction Motor Kit and Cables

- Easy to Install
- Very Flexible
- Longer Life & Reliable
- Lower cost in Long Run
- 3KV 200 Celsius vs. 2Kv 125 Celsius
- Class 1 approved





**“Uniting Innovation, Engineering,
Manufacturing and Distribution”**



TRACTION MOTOR COVERS

Complete Line of Traction Motor Covers **MODIFIED** with **High Heat** Rubber Gaskets.

PowerRail #	Application(s)
E8117405	D7, D17, D27, D37, D47, D57, D67, D75, D77, D87, D90
E8117406	D7, D17, D27, D37, D47, D57, D67, D75, D77, D87, D90
E8176280	D29
E8183868	D7, D17, D27, D37, D57, D67, D75, D77
E8204661	D7, D17, D27, D37, D47, D57, D67, D75, D77, D87
E8204665	D7, D17, D27, D37, D47, D57, D67, D75, D77, D87
E8235994 E8236101	D29
E8300010	D7, D17, D27, D37
E8236103	D29
E8300011	D7, D17, D27, D37, D57, D67, D75, D77
E8300013	D7, D17, D27, D37, D47, D57, D67, D75, D77, D87, D90
E8408599	D57, D67, D75, D77, D87, D90
E8408688	D57, D67, D75, D77



PowerRail #	Application(s)
E8467155	D57, D67, D75, D77
E8467156	D57, D67, D75, D77
E9554330 E40007235	D87, D90
E10520631	D90TR
G4732425G2 G41C636159G2	752AG, 752AH
G41C636160G2	752AH
G4732425G2	752E8, 752AF
G41C636881G1	752AG
G41D731488G1	752E8, 752AF
G4748663G1	752E8, 752AF
G41C637083G2	752AH
G6726556P1	752E8, 752AF
G9961549G1	752

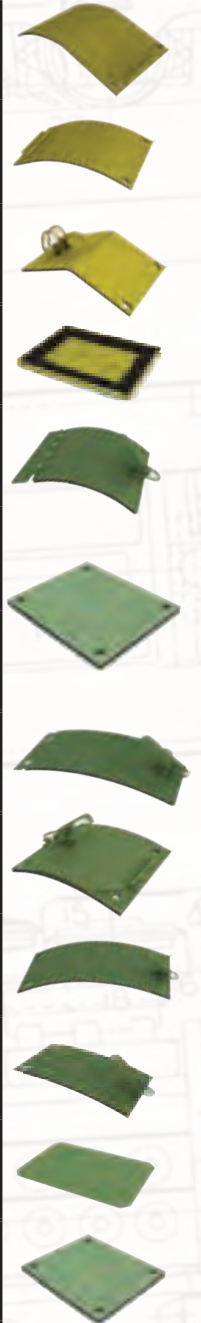



*“Uniting Innovation, Engineering,
Manufacturing and Distribution”*



TURBOCHARGER

Complete Line of New & **“True Blue™”**
Unit Exchange TurboChargers.

We also offer a Complete line of Components
including Spring Drive Gear – Clutch Assemblies,
Turbo Screens, and other Related Parts



- **Class 1 Approved**
- **Quality Parts**
- **Quality Workmanship**
- **Experienced Staff**
- **Technical Support**
- **Competitive Price**
- **Full Line Support Products**

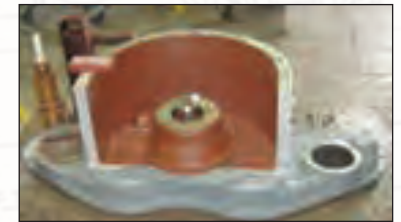

PowerRail PN	Description
E8296440	16cyl 567D3
E8333500	16cyl 567D3
E8358500	16cyl 645E3
E8368596	16cyl 645E3
E8410283	12cyl 645E3
E8413707	12cyl 645E3
E9338194	16cyl 645E3B
E9339283	16cyl 645E3B
E9511706	12cyl 645E3B

PowerRail PN	Description
E9524135	12cyl 645E3B
E9525597	16cyl 645E3B
E9543498	16cyl 645F3B
E9568355	16cyl 710G3
E9564960	16cyl 710G3
E40029631	16cyl 710G3A/B
E40031530	16cyl 710G3A/B
E40053534	16cyl 710G3C
E40059071	16cyl 710G3C



645 & 710 Spring Drives



E9502409
Eductor Tube Outer



E9502412
Eductor Tube Inner

PRD E9557143
Turbo Screen
New or Unit Exchange
Starburst Design!!!!



E9515331 Spring Drive Gear High Capacity 16:8 to 1

E9515338 Spring Drive Gear Standard 18:1 ratio

E9538148 Spring Drive Gear Standard 18:1 ratio

E9538149 Spring Drive Gear High Capacity 16:8 to 1



E40001044 16cyl 710 Clutch UX

E40013863 16cyl 710 Clutch UX

E40028648 12cyl 710 Clutch

E40052862 20cyl 710 Clutch

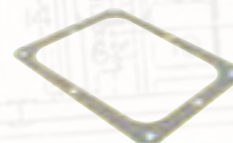

E40089234
Heat Shield

ENHANCEMENT!!!
E40034637 Air Duct
to Turbo Gasket with
Viton for Longer Life



Aftercooler Ducts
New or Unit Exchange





*"Uniting Innovation, Engineering,
Manufacturing and Distribution"*



TREADS, HANDRAIL AND RAILING

Complete Line of FRA Approved Treads, Grab Irons.
Steps, Handrails and Car Body Parts

***Below is a Sampling of Parts**

PowerRail P/N	Description	Comment
E9315313	Tread	GP38
E8342231	Tread	GP38/SD40
E8342230	Tread	GP38/SD40
E9319219	Tread	SD40
E9319220	Tread	SD40
E9315311	Tread	GP38
G41C629248P1	Tread	Dash 7
G41A242229P2	Tread	Dash 7
PRD16184535	Wide Tread	SD40-2



E8123974 Awning 55" Long SD60 SD 70

E9334250 Awning 55 5/8" Long SD60 SD 70

Note: We also Carry Safety Chain
#E8189774 and Breakaway Link 60212

U TUBES

Complete Line of U Tube Housings



PowerRail P/N	Application
E40006120	D87
E40006950	B87BTR
E40035256	D90BTR
E40045090	SD70AC
E40053326	SD90

WEAR PARTS - SHIMS AND SPACERS

Complete Line of Shims and Spacers



PowerRail P/N	Description
G41A210731P4	.062" Shim Air Compressor
40014450	.031" Shim Bearing Flange For Combo's
8061581	.015" Shim Bearing to Bracket
8083559	.020" Shim Bearing Plate
8156922	Shim 11 Gauge
8159285	.063" Main Generator Mounting
8159286	.125" Generator Mounting
8178082	.004" Shim Roots Blower
8194923	.0625" Frame Cover and Support
8348670	AR10 24 Gauge.
8348671	.014" AR10 Shim
8478477	.010" Shim Axle Cap



POWERRAIL

CREATIVE INNOVATIONS ... CONTINUING TRADITION



*“Uniting Innovation, Engineering,
Manufacturing and Distribution”*



WEAR PARTS - TRUCK

Complete Line of Steel, Manganese and Special Molded Wear Parts for All Locomotives

PowerRail P/N	Description
E9085368	Center Plate Liner
E9548794	Center Bowl Liner
E40012754	Center Bowl Liner
E9085369	Center Bowl Liner
E8492124	Center Bowl Liner
G41C629423P1	Center Bowl Liner
G41C629424P1	Center Bowl Liner



E9324108/E4001004 E40012413	EMD Pedestal Liner
G41B515390P1 G41B515390P3	GE Pedestal Liner
E8206915	4" x 3" x 1/4" Nylon Plate
E8206916	5" x 2.625" x 1/4" Plate
E8386454	5.25" x 2.75" x 1/4" Plate
E8088354	10" x 3" x 1/4" Plate
E8336782	3/8" Thick
E8336782	3/4" Thick

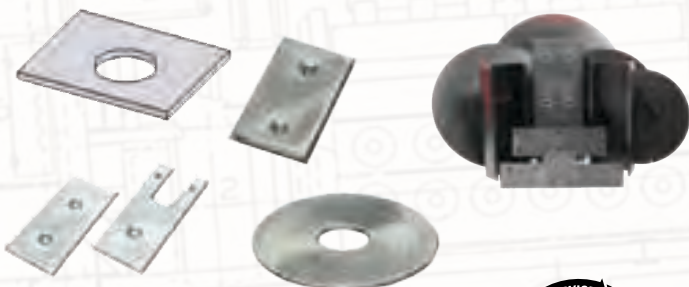

WHEELSETS AND COMBO'S

Complete Line of New & **“True Blue™”**
Unit Exchange Axles, Wheels, Wheelsets
And Combo's

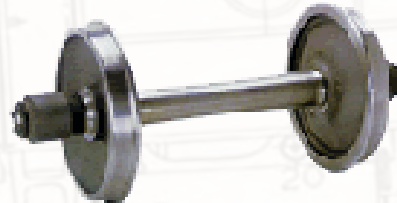

Full Line Of New and Re-Manufactured
Axles and Wheels



Full Line Of New
and Re-Manufactured
Wheelsets Hyatt
and GG Styles



Full Line Of New and Re-Manufactured
U-Tube Style Wheelsets and Traction Motor Combos





*“Uniting Innovation, Engineering,
Manufacturing and Distribution”*



WIPER MOTORS & BLADES

Complete Line of Air Operated Motors, Arms and Blades



***New and Unit Exchange**

PowerRail P/N	Description	Comment
E9088065	Wiper Arm	11"
E8138424	Wiper Arm	12"
E40078283	Wiper Arm	SD70 18"
G84B100880P4	Wiper Arm	18"
G84B513412P	Wiper Arm	18"
E9319906	Wiper Arm	20"
E8148136	Wiper Arm	21"
E40056292	Wiper Arm - Heavy Duty	SD70 13 1/2"
E40056293	Wiper Arm - Heavy Duty	SD70 16"
C-1100-11	Wiper Blade	11"
E8351298	Wiper Blade	12"
E8151270	Wiper Blade	13"
E8037312	Wiper Blade	14"
E8128733	Wiper Blade	15"

PowerRail P/N	Description	Comment
C-1100-17	Wiper Blade	17"
C-1100-18	Wiper Blade	18"
E8407810	Wiper Blade	20"
E10591173	Wiper Hose	8"
E10581390	Wiper Hose	28"
E8155981	Wiper Hose Assy	20 1/4"
E8227244	Wiper Motor	100° Sweep
E8369430	Wiper Motor	50°, 3 3/4" Shaft
E8479945	Wiper Motor	30° Sweep
E8371406	Wiper Motor	50°
E8371408	Wiper Motor	70°
E9506600	Wiper Motor	90° Sweep
E9506601	Wiper Motor - Door	50° Sweep
E9506606	Wiper Motor Cover	—
E8136957	Wiper Motor Repair Kit	40°, 60°, 70°, 80°
E8295087	Wiper Valve	T-Knob
E9316239	Wiper Valve	7/8" Hex





**EMD®
DIESEL ENGINE BOLT TORQUES
(Metric & English)**

Note: When torque values are listed as “initial” and “final,” torquing procedures in the engine manual MUST be followed.

TOP DECK	N•m	Ft-Lbs
Camshaft stubshaft bearing bracket bolts-		
5/8" hex head	285	210
1/2" socket head	102	75
Cylinder head crab nuts (studs & nuts)*		
Initial	407	300
Final (except 645EC engines)	2440	1800
Final (645EC engines)	3254	2400
All engines w/heavy crab plates	3254	2400
Injector crab nuts	68	50
Cylinder head-to-liner nuts*		
Initial	95	70
Final	325	240
Top deck head frame bolts		
280m bolts with captive lockwasher & plain washer	41	30
300m bolts with hardened washers	54	40
Overspeed trip mechanism	32	24
Injector fuel lines	54	40
Camshaft bearing blocks	43	32
Rocker arm shaft nuts*		
Initial	203	150
Final	407	300
Fuel manifold blocks	54	40
Cylinder test valve packing nut	88	65
Water outlet elbow-to-head bolts	41	30
Exhaust manifold-to-crankcase**		
Initial	68	50
Final	176	130
(recheck after 6 months)		
Exhaust manifold connector bolts	108	80
(recheck after 6 months)		
Exhaust manifold inspection cover (when equipped)	108	80

ACCESSORY END		
Accessory drive housing-to-crankcase & oil pan	88	65
Overspeed trip housing-to-crankcase	88	65
Water pump mounting bolts	88	65
Water pump elbows	88	65
Scavenging oil pump mounting bolts	88	65
Scavenging oil pump elbows	88	65
Lube oil pump mounting bolts	88	65

Lube oil pump elbows	88	65
Oil strainer housing mounting bolts	88	65
Governor drive housing mounting bolts	88	65
Governor-to-drive housing	88	65
Overspeed trip cover-to-overspeed trip housing	41	30
Fuel manifolds-to-filter	47	35
Oil strainer elbows-to-strainer housing	54	40
Accessory drive oil seal cover	54	40
Accessory drive coupling		
Single retaining bolt design		
Initial	136	100
Final	678	500
Three retaining bolt design	393	290
Accessory drive flange locking spring bolt	88	65
Governor drive gear assembly		
Stubshaft-to-crankcase	102	75
Stubshaft dowel bolts	23	17
Oil jumper-to-stubshaft	47	35
Retainer plate-to-stubshaft	47	35
Governor drive flange-to-drive gear	47	35

CAMSHAFT DRIVE END		
Piston cooling manifold flange-to-crankcase	37	27
Idler gear stubshaft bracket-to-crankcase		
1/2"	122	90
3/8"	37	27
5/16" (dowel bolts)	23	17
No. 1 idler gear thrust plate		
1/2" (to stubshaft)	102	75
5/8" (to crankshaft)	251	185
Camshaft drive gear and counter-weight-to-camshaft		
1/2"	122	90
5/16" (dowel bolts)	23	17

	N•m	Ft-Lbs
Camshaft drive housing-to-crankcase	88	65
Oil manifold-to-oil manifold	50	37
Oil manifold-to-crankcase	43	32
Oil slinger-to-crank shaft gear	23	17
Oil retainer-to-camshaft drive housing	41	30

TURBO ENGINES ONLY		
Turbocharger mounting bolts-		
3/4"	238	175
1/2"	88	65
Air ducts-to-turbocharger	81	60
Air ducts-to-crankcase	88	65
Auxiliary drive-to-turbocharger		
3/8"	32	24
1/2"	88	65
Aftercooler-to-air duct	61	45



Aftercooler support pad bolts	176	130
Turbocharger-to-manifold**	122	90
Water piping-to-aftercooler	47	35
Water piping-to-engine	47	35
Oil separator bolts, attaching	122	90
Oil separator expansion joint.....	35	25
Camshaft drive housing-to-crankcase lockwire anchor bolts	88	65

BLOWER ENGINES ONLY

Blower rotor shaft nut	678	500
Blower timing gear cover nut.....	47	35
Blower end plate-to-housing nuts.....	88	65
Blower support-to-crankcase.....	238	175
Blower-to-support.....	88	65
Blower drain lines	88	65
Auxiliary drive housing-to-crankcase	238	175
Blower drive gear stubshaft bracket-to-crankcase	122	90
Camshaft drive gear cover-to-housing.....	88	65

CRANKCASE AND OIL PAN

Main bearing nuts*		
Initial	475-	350-
Final	542	400
Final	1017	750
Crankcase-to-oil pan		
Initial	136	100
Final	610	450
Connecting rod-to-piston pin*	610	450
Piston pin retainer bolts*		
1/4" Bolts	16.2	12
5/16" Bolts	38	28
Basket-to connecting rod*		
Initial	13	10
Final	258	190
Connecting rod basket	102	75
Piston cooling oil pipe bolts.....	27	20
Water jumper-to-liner	41	30
Water jumper saddle strap nuts.....	20	15
Damper/balancer-to-crankshaft.....	678	500
Bolt-on crankshaft stubshaft*		
(where applicable	678	500
Bolt-on crankshaft stubshaft retention bolts.....	81	60
Accessory drive gear to crankshaft*		
7/8"	678	500
3/4"	407	300
5/8"	217	160
Accessory drive gear oil slinger	33	24
Coupling disc-to-crankshaft		
8, 12, & 16 cyl.....	2440	1800

20 cyl	1830	1350
Coupling disc rim bolts.....	400	295
Handhole cover bolts	27-41	20-30
Engine mounting bolts.....	617	455
Engine mounting bolts w/sleeves.....	881	650

*Lubricate with Texaco Threadtex No. 2303

**Lubricate with Fel-Pro C5A or equivalent

**MODEL 645 (BLOWER) ENGINE-SYSTEM
TEMPERATURES AND PRESSURES**

Lubrication Oil System

Pressure At Normal Operating Temperature	
At Governor Connection (Nominal)	40 - 70 psi
Temperature	
T1, To Engine (from cooler).....	175°-200°F
T2, From Engine (to cooler)	195°-200°F
T, Temperature Differential	20°-25°F
Alarm Settings	
ELOS, Engine Lube Oil Switch	
Rated Speed	17 - 21 psi
Idle Speed	5 - 9 psi
ELOT, Engine Lube High Temperature Switch (into engine)	220°F

Fresh Water System

Pressure Rise Across Fresh Water Pump At 900 RPM (minimum 0 psi at pump inlet)	
8 Cylinder.....	45 ± 3 psi
12 Cylinder.....	53 ± 3 psi
16 Cylinder.....	45 ± 3 psi
Temperature	
T1, To Engine	165°-180°F
T2, From Engine	175°-190°F
T, Temperature Differential	8°-15°F
T3, From Fresh Water Cooler	
To Lube Oil Cooler	150°-165°F
Alarm Setting	
EWT, Engine Water Temperature (from engine)	200°F

Raw Water System

Pressure Rise Across Raw Water Pump At 900 RPM (maximum suction-2 psi at pump inlet)	
With Gear Cooler	
8 Cylinder.....	41 ± 2 psi
12 Cylinder.....	43 ± 2 psi
16 Cylinder.....	43 ± 2 psi
Without Gear Cooler	
8 Cylinder.....	46.5 ± 2 psi
12 Cylinder.....	47 ± 2 psi
16 Cylinder.....	47 ± 2 psi





Design Temperature

T1, To Fresh Water Cooler (maximum)	85°F
T2-T1, Raw Water Temperature Rise Across Fresh Water Cooler	
8 Cylinder	41 ± 2 psi
12 Cylinder	43 ± 2 psi
16 Cylinder	43 ± 2 psi

Fuel System

Pressure	
G1, at Filter Outlet (to engine)	12 - 25 psi

**MODEL 645 (TURBO) ENGINE-SYSTEM
TEMPERATURES AND PRESSURES**

Lubrication Oil System

Pressure At Normal Operating Temperature	
At Governor Connection (Nominal)	60 - 100 psi
Temperature	
T1, To Engine (from cooler)	175°-195°F
T2, From Engine (to cooler)	195°-220°F
T, Temperature Differential	20°-25°F
Alarm Settings	
ELoS, Engine Lube Oil Switch	
Rated Speed	26 - 30 psi
Idle Speed	10 - 14 psi
LO2, Soak Back Pump Low Oil Pressure (rising pressure)	10 psi
ELOT, Engine Lube High Temperature Switch (into engine)	220°F

Fresh Water System

Pressure Rise Across Fresh Water Pump At 900 RPM (minimum 0 psi at pump inlet)	
8 Cylinder	47 ± 3 psi
12 Cylinder	48 ± 3 psi
16 Cylinder	55 ± 3 psi
20 Cylinder	55 ± 3 psi
Temperature	
T1, To Engine	165°-180°F
T2, From Engine	175°-190°F
T, Temperature Differential	8°-15°F
T3, From Fresh Water Cooler To Lube Oil Cooler	150°-165°F
Alarm Setting	
EWT, Engine Water Temperature (from engine)	200°F
Temperature	
T, Oil to Water	25°F Max.

Raw Water System

Pressure Rise Across Raw Water Pump At 900 RPM (maximum suction-2 psi at pump inlet)	
With Gear Cooler	
8 Cylinder	43 ± 2 psi
12 Cylinder	43 ± 2 psi
16 Cylinder	32 ± 2 psi
20 Cylinder	32 ± 2 psi
Without Gear Cooler	
8 Cylinder	47 ± 2 psi
12 Cylinder	47 ± 2 psi
16 Cylinder	41 ± 2 psi
20 Cylinder	32 ± 2 psi
Design Temperature	
T1, To Fresh Water Cooler (maximum)	85°F
T2-T1, Raw Water Temperature Rise Across Fresh Water Cooler	
8 Cylinder	7°-13°F
12 Cylinder	11°-17°F
16 Cylinder	13°-19°F
20 Cylinder	17°-23°F

Fuel System

G1, at Filter Outlet (to engine)	12 - 25 psi
----------------------------------	-------------





*“Uniting Innovation, Engineering,
Manufacturing and Distribution”*



NOTES:



MISSION STATEMENT

It is the objective of PowerRail Distribution Inc. to provide Products and Services that meet our exemplary standards of Quality, Service, Delivery and Value....which consistently meets or exceeds our customer's expectations.



Disclaimer

PowerRail Distribution offers a wide range of aftermarket replacement parts for EMD and GETS brand Locomotives.

We **do not** claim to be an authorized distributor for EMD (Electro-Motive Diesels Inc.) or GETS (General Electric Transportation) nor claim to offer any Genuine OEM factory parts.

Please feel free to contact us anytime with any Questions or Comments.

WWW.ePowerRail.ComTM



POWERRAIL

CREATIVE INNOVATIONS...CONTINUING TRADITION

Dedication at Every Turn.

POWERRAIL DISTRIBUTION INC.

205 Clark Road, Duryea, PA 18642 USA

Phone: 570.883.7005 • Fax: 570.883.7006

Sales@epowerrail.com • www.ePowerRail.com

